



6.0 GIB® PERFORMANCE SYSTEMS

The GIB® Performance Systems section covers installation of GIB EzyBrace® and GIB Aqualine®

Wet Area Systems. For other systems refer to the appropriate GIB® systems literature.

6.1 GIB® BRACING SYSTEMS

This section covers the installation of GIB EzyBrace® Systems to timber framing to NZS 3604:2011. Full design details can be found in the GIB EzyBrace® Systems literature.

Bracing of steel framed walls is by specific design. For assistance refer to the document GIB EzyBrace® for Light Steel Frame Systems available from gib.co.nz or nashnz.org.nz.

GIB® Bracing elements code system:	
GS	GIB® Standard plasterboard
BL	GIB Braceline®
W	GIB Weatherline®
P	7mm structural plywood manufactured to AS/ NZS 2269:2012
1	Bracing element fixed to one side of the wall only
2	Bracing element fixed to both sides of the wall
N	Panel hold down not required
H	GIB HandiBrac® or metal strap and hold down bolt
NOM	Nominal fixing as per p.41-42

6.1.1 Installation Summary - Internal System Options

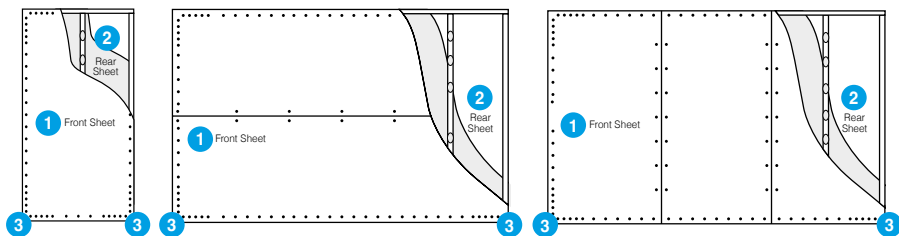

	Front Sheet 1		Rear Sheet 2		Panel Hold-Down Fixings 3	Fastener Spacing
	Lining	Fasteners	Lining	Fasteners		
GS2-NOM	Any 10mm or 13mm GIB® plasterboard	Minimum 32mm x 6g GIB® Grabber® high thread screws	Any 10mm or 13mm GIB® plasterboard	Minimum 32mm x 6g GIB® Grabber® high thread screws	Not Required	Corner fastening pattern as illustrated on p.71. All four corners of GS2-NOM bracing element must be fastened at 50mm max and 250mm max from the edge of the sheet at 300mm max centres
GS1-N	Any 10mm or 13mm GIB® plasterboard	Minimum 32mm x 6g GIB® Grabber® high thread screws	Not Required	Not Required	Not Required	GIB® Plasterboard Corner fastening pattern as illustrated on p.71. Fasteners at 150mm max to bracing element perimeter and: at 300mm max centres to intermediate sheet joints for vertical fixing, or at stud/sheet junction for horizontally fixed elements, and GIBFix® adhesive daubs at 300mm max are to intermediate framing
GS2-N			Any 10mm or 13mm GIB® plasterboard	32mm x 6g GIB® Grabber® high thread screws		
GSP-H			Minimum 7mm structural plywood manufactured to AS/NZS 2269	50mm x 2.8mm flat head galvanised or stainless steel nails	Yes	Structural Plywood Fasteners at 150mm max around the perimeter of every sheet and at 300mm max centres to intermediate studs. Place fasteners no closer than 7mm from sheet edges. Plasterboard corner fastener pattern does not apply to plywood
BL1-H	10mm or 13mm GIB Braceline®	Minimum 32mm x 6g GIB® Grabber® high thread screws	Not required	Not required		
BLG-H			Any 10mm or 13mm GIB® plasterboard	32mm x 6g GIB® Grabber® high thread screws		
BLP-H			Minimum 7mm structural plywood manufactured to AS/ NZS 2269	50mm x 2.8mm flat head galvanised or stainless steel nails		

Note: Minimum bracing element length is 400mm

Scan to view GIB® installation videos



6.1.2 Internal Bracing System Specifications

GS2-NOM

1. 10mm or 13mm GIB® Standard plasterboard fixed to each side of the wall framing
2. Corner fastening pattern applies (see p.71)
3. 32mm x 6g GIB® Grabber® screws or GIB® Grabber® Dual Thread screws at 300mm max to perimeter
4. Panel hold downs not required
5. Centre of the sheet may be fixed with adhesive or fastenings at 300mm max
6. Joints must be stopped
7. GIB® tape must be used in joints
8. Sheets may be fixed horizontally or vertically

Bracing Element – Plasterboard side shown

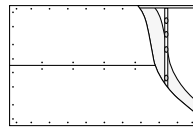

Horizontal Fixing

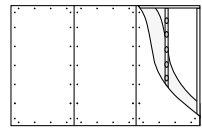

Vertical Fixing

GS1-N

1. Any 10mm or 13mm GIB® plasterboard to one side of the wall only
2. Corner fastening pattern applies (see p.71)
3. 32mm x 6g GIB® Grabber® screws or GIB® Grabber® Dual Thread screws at 150mm max to perimeter
4. Centre of the sheet may be fixed with adhesive or fastenings at 300mm max
5. Panel hold downs not required
6. Joints must be stopped
7. GIB® tape must be used in joints
8. Sheets may be fixed horizontally or vertically

Bracing Element – Plasterboard side shown

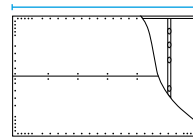

Horizontal Fixing

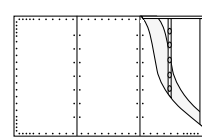

Vertical Fixing

GS2-N

1. Any 10mm or 13mm GIB® plasterboard to both sides of the wall. Both sides fixed as bracing elements
2. Corner fastening pattern applies (see p.71)
3. 32mm x 6g GIB® Grabber® screws or GIB® Grabber® Dual Thread screws at 150mm max to perimeter
4. Centre of the sheet may be fixed with adhesive or fastenings at 300mm max
5. Panel hold downs not required
6. Joints must be stopped
7. GIB® tape must be used in joints
8. Sheets may be fixed horizontally or vertically

Bracing Element – Plasterboard side shown

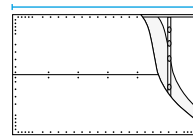

Horizontal Fixing

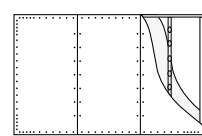

Vertical Fixing

GSP-H

1. Any 10mm or 13mm GIB® plasterboard to one side of the wall
2. 7mm structural plywood to the other side
3. Corner fastening pattern applies (see p.71)
4. 32mm x 6g GIB® Grabber® screws or GIB® Grabber® Dual Thread screws at 150mm max to perimeter (plasterboard side) 50 x 2.8mm FH nails at 150mm max to perimeter. Corner fastening pattern not applicable to plywood side
5. Panel hold downs required
6. Centre of the sheet may be fixed with adhesive or fastenings at 300mm max
7. Joints must be stopped
8. GIB® tape must be used in joints
9. Sheets may be fixed horizontally or vertically

Bracing Element – Plasterboard side shown

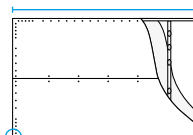

Horizontal Fixing

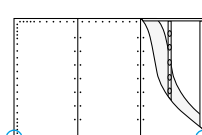

Vertical Fixing

BL1-H

1. 10mm or 13mm GIB Braceline® to one side of the wall only
2. Corner fastening pattern applies (see p.71)
3. 32mm x 6g GIB® Grabber® screws or GIB® Grabber® Dual Thread screws at 150mm max to perimeter
4. Centre of the sheet may be fixed with adhesive or fastenings at 300mm max
5. Panel hold downs required
6. Joints must be stopped
7. GIB® tape must be used in joints
8. Sheets may be fixed horizontally or vertically

Bracing Element – Plasterboard side shown

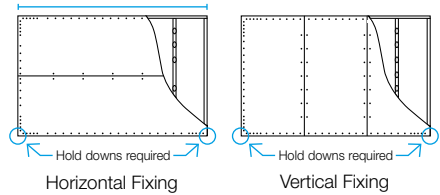

BLG-H

1. 10mm or 13mm GIB Braceline® to one side of the wall
2. Any 10mm or 13mm GIB® plasterboard to the other side. Both sides fixed as bracing elements
3. Corner fastening pattern applies (see p.71)
4. 32mm x 6g GIB® Grabber® screws or GIB® Grabber® Dual Thread screws at 150mm max to perimeter
5. Centre of the sheet may be fixed with adhesive or fastenings at 300mm max
6. Panel hold downs required
7. Joints must be stopped
8. GIB® tape must be used in joints
9. Sheets may be fixed horizontally or vertically

Bracing Element – Plasterboard side shown

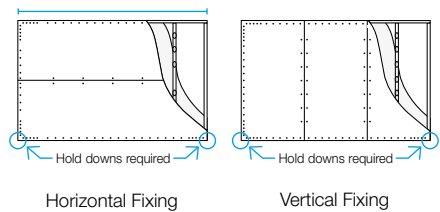

BLP-H

1. 10mm or 13mm GIB Braceline® to one side of the wall only
2. 7mm structural plywood to the other side
3. Corner fastening pattern applies (see p.71)
4. 32mm x 6g GIB® Grabber® screws or GIB® Grabber® Dual Thread screws at 150mm max to perimeter (plasterboard side). 50 x 2.8mm FH nails at 150mm max to plywood perimeter. Corner fastening pattern not applicable (plywood side)
5. Panel hold downs required
6. Centre of the sheet may be fixed with adhesive or fastenings at 300mm max
7. Joints must be stopped
8. GIB® tape must be used in joints
9. Sheets may be fixed horizontally or vertically

Bracing Element – Plasterboard side shown

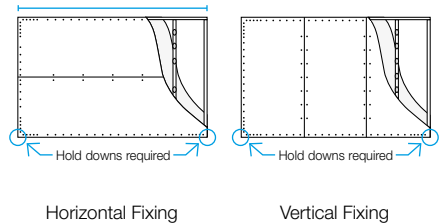

For sheet substitution options refer to p.14.

Scan to view GIB® installation videos



6.1.3 Installation Summary - Exterior System Options

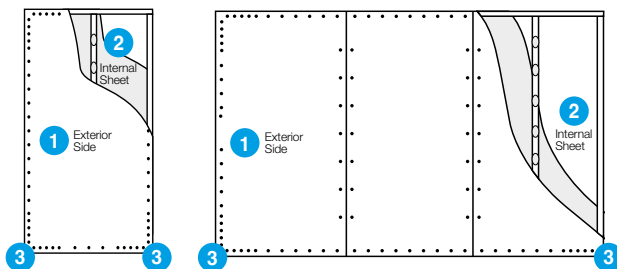

	Exterior Side 1			Internal Sheet 2			Panel Hold-Down Fixings 3
	Lining	Fasteners	Fastener Spacing	Lining	Fasteners	Fastener Spacing	
GSW-N GSW-H	10mm or 13mm GIB Weatherline®	41mm x 6g GIB® Grabber® ceramic coated high thread screws.	<p>Corner screw placement as illustrated on p.71.</p> <p>Screw placement at 150mm max to sheet perimeter.</p> <p>Centre of the sheet fixed at 300mm max.</p>	Any 10mm or 13mm GIB® plasterboard	32mm x 6g GIB® Grabber® high thread screws	<p>Corner screw placement as illustrated on p.71.</p> <p>Screw placement at 150mm max to sheet perimeter.</p> <p>Centre of the sheet may be fixed with adhesive or fastenings at 300mm max.</p>	<p>Not Required</p> <p>Yes</p>
W-H				Not Required			Yes
BLW-H				10mm or 13mm GIB Braceline®/ Noiseline®	32mm x 6g GIB® Grabber® high thread screws	<p>Corner screw placement as illustrated on p.71.</p> <p>Screw placement at 150mm max to sheet perimeter.</p> <p>Centre of the sheet may be fixed with adhesive or fastenings at 300mm max.</p>	Yes

Note: Minimum bracing element length is 400mm

GSW-N

- Corner fastening pattern applies (see p.71)
- Panel hold downs not required

Exterior Side

1. 10mm or 13mm GIB Weatherline® to exterior side of the wall
2. Fasteners 41mm x 6g GIB® Grabber® ceramic coated high thread screws
3. Refer to wind loading section for the GIB Weatherline® Design and Construction Manual for fastener centres
4. All joints and screw fixing must be taped with GIB Weatherline® Flashing Tape, no plaster stopping is required

- Corner fastening pattern applies (see p.71)
- Panel hold downs not required

Internal Side

1. Any 10mm or 13mm GIB® plasterboard to one side of the wall only
2. Corner fastening pattern applies (see p.71)
3. 32mm x 6g GIB® Grabber® screws or GIB® Grabber® Dual Thread screws at 150mm max to perimeter
4. Centre of the sheet may be fixed with adhesive or fastenings at 300mm max
5. Panel hold downs not required
6. Joints must be stopped
7. GIB® tape must be used in joints
8. Sheets may be fixed horizontally or vertically

Bracing Element – Internal side

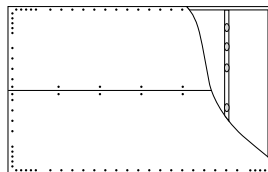

Horizontal Fixing

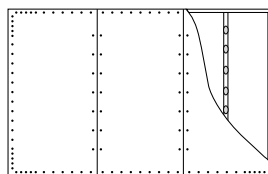

Vertical Fixing

GSW-H

- Corner fastening pattern applies (see p.71)
- Panel hold downs required

Exterior Side

1. 10mm or 13mm GIB Weatherline® to exterior side of the wall
2. Fasteners 41mm x 6g GIB® Grabber® Ceramic Coated High Thread Screws
3. Refer to wind loading section for the GIB Weatherline® Design and Construction Manual for fastener centres
4. All joints and screw fixings must be taped with GIB Weatherline® Flashing Tape, no plaster stopping is required

Internal Side

1. 10mm or 13mm GIB Braceline® to one side of the wall only
2. Corner fastening pattern applies (see p.71)
3. 32mm x 6g GIB® Grabber® screws or GIB® Grabber® Dual Thread screws at 150mm max to perimeter
4. Centre of the sheet may be fixed with adhesive or fastenings at 300mm max
5. Panel hold downs required
6. Joints must be stopped
7. GIB® tape must be used in joints
8. Sheets may be fixed horizontally or vertically

Bracing Element – Interior side

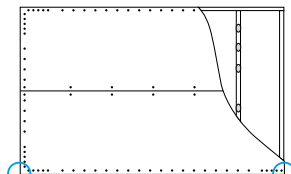

Horizontal Fixing

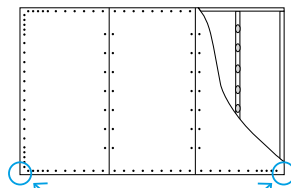

Vertical Fixing

For sheet substitution options refer to p.14.

6.1.4 Exterior Bracing Systems Specifications

W-H

- Corner fastening pattern applies (see p.71)
- Panel hold downs required

Exterior Side

1. 10mm or 13mm GIB Weatherline® to exterior side of the wall
2. Fasteners 41mm x 6g GIB® Grabber® Ceramic Coated High Thread Screws
3. Screw placement at 150mm max to sheet perimeter
4. Centre of the sheet fixed at 300mm max
5. All joints and screw fixings must be taped with GIB Weatherline® Flashing Tape, no plaster stopping is required

Bracing Element – Exterior side

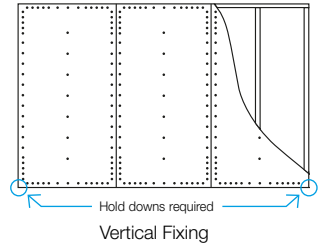

BLW-H

- Corner fastening pattern applies (see p.71)
- Panel hold downs required

Exterior Side

1. 10mm or 13mm GIB Weatherline® to exterior side of the wall
2. Fasteners 41mm x 6g GIB® Grabber® Ceramic Coated High Thread Screws
3. Refer to wind loading section for the GIB Weatherline® Design and Construction Manual for fastener centres
4. All joints and screw fixings must be taped with GIB Weatherline® Flashing Tape, no plaster stopping is required

Internal Side

1. Any 10mm or 13mm GIB® plasterboard to one side of the wall only
2. Corner fastening pattern applies (see p.71)
3. 32mm x 6g GIB® Grabber® screws or GIB® Grabber® Dual Thread screws at 150mm max to perimeter
4. Centre of the sheet may be fixed with adhesive or fastenings at 300mm max
5. Panel hold downs not required
6. Joints must be stopped
7. GIB® tape must be used in joints
8. Sheets may be fixed horizontally or vertically

Bracing Element – Interior side

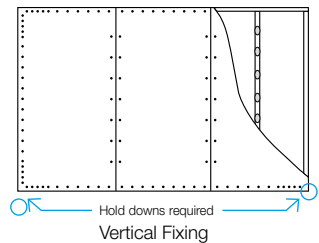
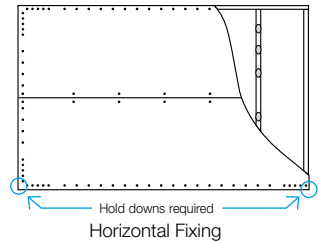

For sheet substitution options refer to p.14.

Scan to view GIB® installation videos



6.1.5 Bottom Plate Fixing

Bottom Plate Fixings for GIB® Bracing Elements

Brace Type	Concrete Slabs		Timber Floors
	External Walls	Internal Walls	External and Internal Walls
GS1-N GSW-N	As per NZS 3604:2011 No specific additional fastening required	As per NZS 3604:2011 Alternatively use 75 x 3.8mm shot-fired fasteners with 16mm discs, 150mm and 300mm from each end of the bracing element and at 600mm thereafter.	Pairs of 100 x 3.75mm flat head hand driven nails or 3/90 x 3.15mm power driven nails at 600mm centres in accordance with NZS 3604:2011
GS2-N GS2-NOM	Not applicable		
GSP-H BL1-H BLP-H GSW-H W-H BLW-H	Intermediate fastenings to comply with NZS 3604:2011 In addition: GIB HandiBrac® fixings or metal wrap-around strap fixings and bolt as illustrated on p.69-70		Pairs of 100 x 3.75mm flat head hand driven nails or 3/90 x 3.15mm power driven nails at 600mm centres in accordance with NZS 3604:2011 In addition: GIB HandiBrac® fixings or metal wrap-around strap fixings and bolt as illustrated below
BLG-H	Not applicable	As for GSP-H, BL1-H, BLP-H on concrete slab as illustrated on p.69-70	

6.1.6 Panel Hold-Down Details

GIB HandiBrac® – Recommended Method

Developed in conjunction with MiTek™ NZ, the GIB HandiBrac® has been designed and tested for use as a hold-down in GIB® BL and GSP bracing elements.

- The GIB HandiBrac® registered design provides for quick and easy installation
- The GIB HandiBrac® provides a flush surface for the wall linings because it is fitted inside the framing. There is no need to check into the framing as recommended with conventional straps
- The GIB HandiBrac® is suitable for both new and retrofit construction
- The design also allows for installation and inspection at any stage prior to fitting internal linings

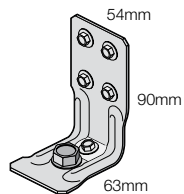

Concrete Floors		Timber Floors	
External Walls	Internal Walls	External Walls	Internal Walls
<p>Position GIB HandiBrac® as close as practicable to the internal edge of the bottom plate</p>	<p>Position GIB HandiBrac® at the stud / plate junction</p>	<p>Position GIB HandiBrac® in the centre of the perimeter boundary joist</p>	<p>Position GIB HandiBrac® in the centre of floor joist or full depth solid block</p>

Hold-Down Fastener Requirements

A mechanical fastening with a minimum characteristic uplift capacity of 15kN or use supplied BT 10/140 screw bolt in GIB HandiBrac® pack.

12 x 150mm galvanised coach screw or use supplied BT 10/140 screw bolt in GIB HandiBrac® pack.

Bracing Strap Installation

Care needs to be taken with the installation of the bracing strap. It should be checked in to be flush with the face of the stud providing a flat substrate for the plasterboard. It should be positioned in such a way that the important corner fastenings of the bracing element are not affected by it. Keeping the strap to the edge of the end stud as shown will allow the important corner fastenings to be installed without having to penetrate the bracing strap.

Concrete Floors

Timber Floors

400 x 25 x 0.9mm galvanised strap to pass under the plate and up the other side of the stud. Six 30 x 2.5 flat head galvanised nails to each side of the stud. Three 30 x 2.5 flat head galvanised nails to each side of the plate. Hold down bolt with 50 x 50 x 3mm washer to be fitted within 80mm of the edge of the element.

Internal Walls	External Walls	Internal Walls	External Walls
			<p>2/300 x 25 x 0.9mm galvanised straps with six 30 x 2.5mm flat head galvanised nails to each stud and into the floor joist and three nails to the plate. Block to nog fixed with 3/100 x 3.75mm nails to stud.</p>

Hold-Down Fastener Requirements

Concrete Floors

A mechanical fastening with a minimum characteristic uplift capacity of 15kN fitted with a 50 x 50 x 3mm square washer within 80mm of the ends of the bracing element.

Timber Floors

12 x 150mm galvanised coach screw fitted with a 50 x 50 x 3mm square washer within 80mm of the ends of the bracing element.

Scan to view GIB® installation videos



6.1.7 GIB EzyBrace® Corner Fastener Pattern

Corner Fastener Pattern for ALL 4 CORNERS OF GIB® Bracing Elements (excluding GS2-NOM).

- All four corners of a GIB® plasterboard bracing element must be fastened as per the fastening patterns shown below

- Bracing element perimeter is then fastened at 150mm centres, or for GS2-NOM 300mm centres
- Fasteners must be no closer than 12mm from the paper enclosed edge and no closer than 18mm from sheet ends or cut edges of sheets

GIB EzyBrace® Corner Fastener Pattern

Unless specified all fastener spacings are maximums.

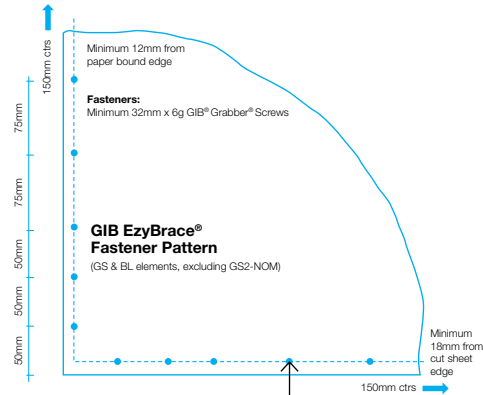

Note: For panels between 400mm and 450mm place this fastener centrally

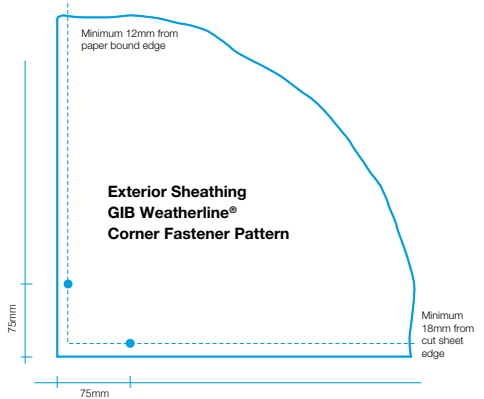

Refer to wind loading section of the GIB Weatherline® Design and Construction Manual for fastening centres, except when installing a W-H bracing element where the GIB EzyBrace® fastener pattern will apply.

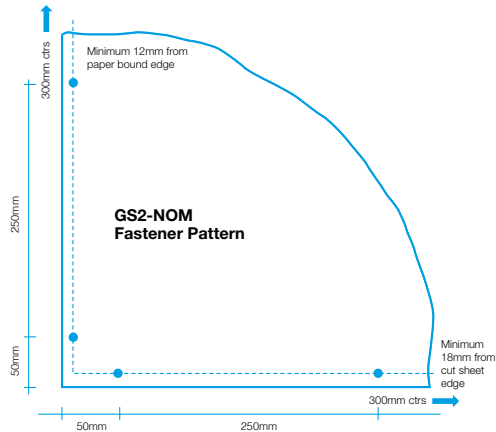

6.1.8 General Installation Details

- Timber framing to comply with NZS 3604:2011
- Minimum stud dimensions:
 - External walls – 90 x 35mm
 - Internal walls – 70 x 45mm
- Use full sheets where possible
- If part sheets are required a min dimension of 300mm applies for all bracing elements
- All joints and fastener heads in GIB EzyBrace® Systems must be stopped. GIB® tape must be used in joints

Bracing in Wet Areas

GIB EzyBrace® Systems are not to be installed inside shower cubicles or around baths.

Outside of these areas it is acceptable to use GIB EzyBrace® Systems in bathrooms and other wet areas provided that the surface of the element is maintained impervious for the life of the building.

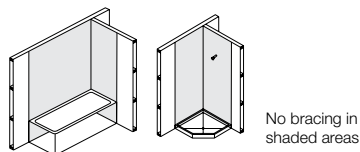

Small Openings in Bracing Elements

Small openings (e.g. power outlets) of 90 x 90mm maximum or circular holes no more than 100mm may be placed no closer than 90mm to the edge of the braced element. A block may need to be provided alongside the perimeter stud as shown below.

When more than 1 small opening is required to be placed in a bracing element, contact the GIB® Helpline for further guidance.

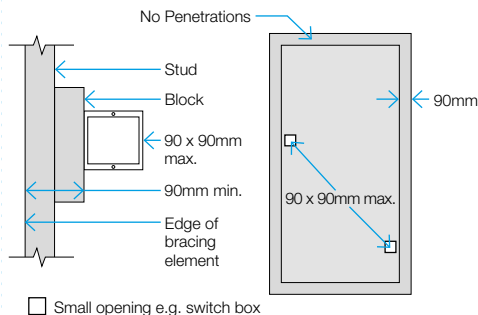

Large Openings in Bracing Elements

For openings above 90 x 90mm such as switch boards, recessed cabinets and TV's etc. should be placed outside of the bracing element or locate the bracing element on the other side of the wall framing.

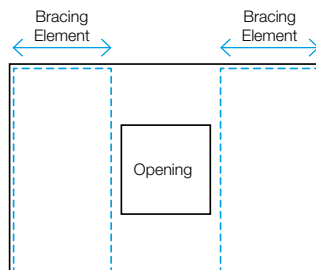

Intersecting Walls

GIB® Bracing Elements may have intersecting walls with a min length of 200mm. Fasteners are required around the perimeter of the bracing element. Vertical joints at T-junctions must be fixed and jointed as specified for intermediate sheet joints. The bracing element length must be no less than 900mm.

Where a Wall Bracing Element is interrupted by a T-junction the element is deemed to be continuous for the whole length (900mm min in the example illustrated).

When fixing part sheets of GIB® plasterboard to the side of a T-junction, a min width of 300mm applies for bracing elements. See figures on p.73.

6.1.8 General Installation Details

Intersecting Walls

Conventional wall layout

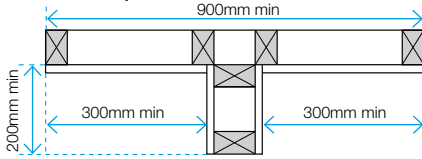

GIBFix® framing alternative wall layout option

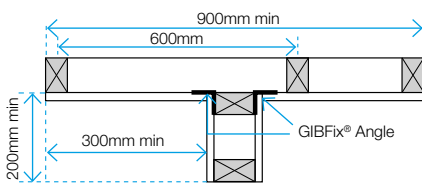

Place nogs at 800mm centres to support GIBFix® Angles.
For more information on the GIBFix® framing system refer to the applicable technical literature at gib.co.nz

Example using fastener pattern for GS and BL elements

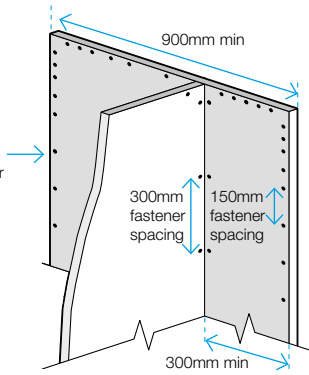

Junction
Minimum 32mm x 6g GIB® Grabber® High Thread or 32mm x 7g GIB® Grabber® Dual Thread Screws at 300mm centres each side

Top Plate Connections

For top plate connection refer to NZS3604:2011 section 8.7.3.

Parapets and Gable End Walls

Bracing elements must be fixed from top plate to bottom plate. Fixing to a row of nogs is not acceptable unless either:

A continuous member such as an 90 x 45mm ribbon plate is fixed across the studs just above a row of nogs at the ceiling line;

OR

GIBFix® Angle is installed as shown. The angle is fixed to a row of nogs with 30 x 2.5mm galvanised flat head nails at 300mm centres.

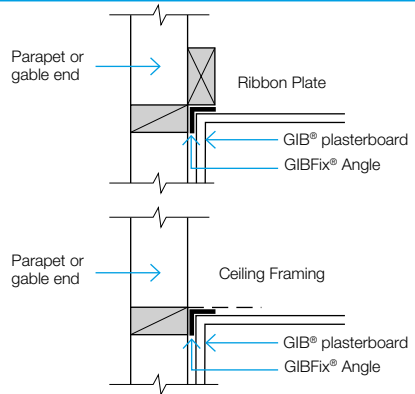

Screw and Adhesive Fix for Openings - GS2-NOM Only

— GIBFix® All-Bond Adhesive

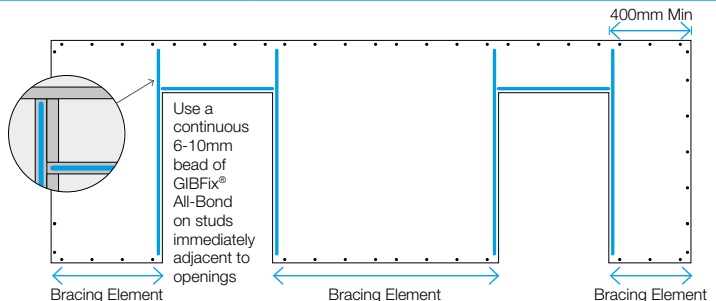

6.1.9 Ceiling Diaphragms

Ceiling diaphragms do not have a bracing unit rating but are used when bracing lines are spaced further than 6.0m apart.

Any 10mm or 13mm GIB® plasterboard can be used for ceiling diaphragms.

Ceiling Diaphragms

Small Openings

Small opening (e.g. down lights) of 90 x 90mm or less may be placed no closer than 90mm to the edge of the ceiling diaphragm.

Large Openings

Openings are allowed within the middle third of the diaphragms length and width. Fixing of sheet material to opening trimmers should be at 150mm centres. Neither opening dimension should exceed a third of the diaphragm width. Larger openings or openings in other locations require specific engineering design.

Flue and Range Hood Openings

Where flue or range hood openings are required in a ceiling diaphragm the use of a galvanised metal backing plate is recommended, with a max hole diameter of 350mm.

Note: Backing plate detail can be used for range hood openings in walls.

For more information refer to the GIB Ezybrace® technical manual.

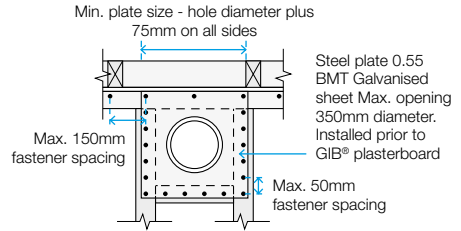
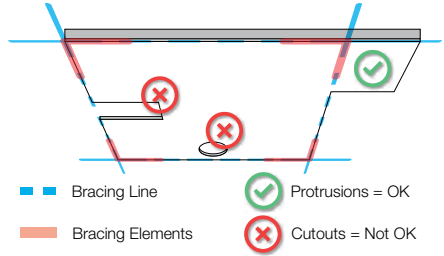

Plasterboard ceiling not shown in plan view

Use full width sheets where possible.

Minimum length sheet – 1.8m

Minimum width sheet – 900mm

Sheets less than 900mm in width but no less than 600mm may be used provided that the sheet edge joint is fully back blocked.

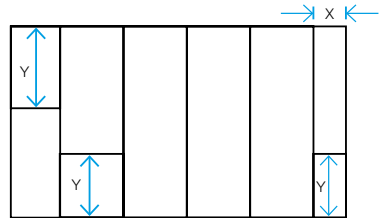

X = 900mm min or 600-900mm min provided all adjacent joints are back-blocked

Y = 1800mm min sheet lengths at ends of ceiling diaphragms

Ceiling diaphragms may be constructed using any GIB® plasterboard provided perimeter fixing is at;

150mm centres for: Diaphragms up to 7.5m in length, no steeper than 15°.

100mm centres for: Diaphragms up to 7.5m in length, no steeper than 45°. Diaphragms up to 12m in length, no steeper than 25°.

Diaphragms outside these parameters must be specifically designed.

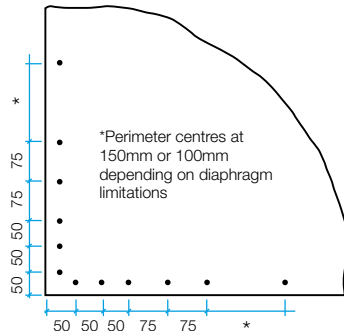

All fastener spacings are maximums

Ceiling Diaphragms

GIB® Rondo® 310 metal ceiling battens may be used if fixed directly through the flanges into the ceiling framing using 2/32mm x 8g wafer head screws.

If the 310 ceiling battens are required to be clip fixed, a block or continuous timber member must be securely attached to the ceiling framing at the level of the back of the metal batten. The batten is then fastened to this timber as shown.

Block or continuous timber member min 300mm fixed with min 4 x 100mm x 3,75mm nails

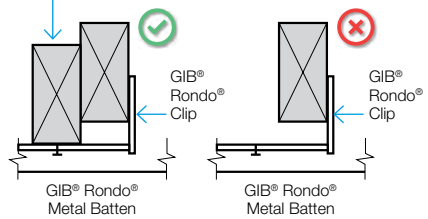

For steel battens a continuous channel or angle is required to the perimeter of the diaphragm.

This must be fastened to the framing with GIB® Grabber® 32mm x 8g wafer head screws at 300mm centres.

Battens must be fixed to the channel with 32mm x 8g GIB® Grabber® wafer head screws.

It is important that a positive connection is created between the top plate and the ceiling substrate.

Covered ceiling diaphragms can be achieved by attaching a folded metal angle to the junctions.

- Minimum .55mm BMT with 100mm each leg
- Fastened at 300mm centres on each edge using 32mm x 6g GIB® wafer head screws

Linings must be fixed to both sides of the metal angle at 150mm or 100mm centres with minimum 25mm x 6g GIB® Grabber® self-tapping screws

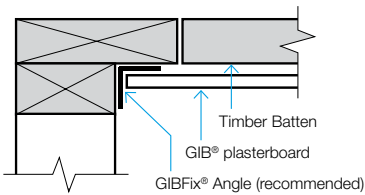
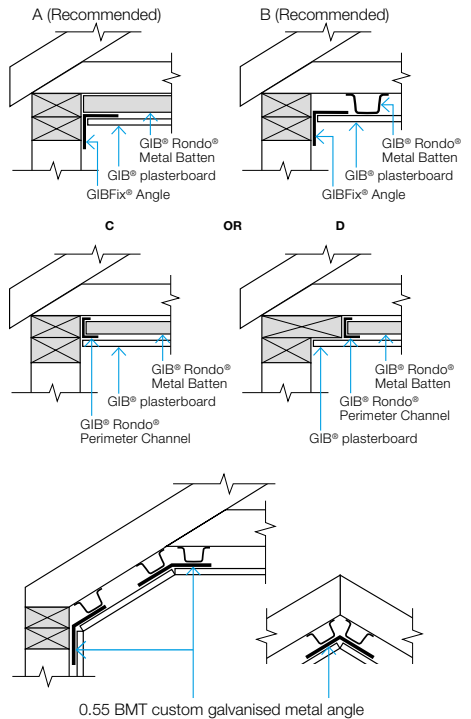

General installation

- Sheet end butt joints must be formed off framing and back-blocked (see p.50)
- Framing and ceiling batten requirements for ceiling diaphragms are the same as for general ceiling installation (see p.48)
- The body of the ceiling must be fixed as per general ceiling installation (see p.48)

- Openings and penetrations in ceiling diaphragms are as for wall bracing (see p.74)
- Linings must be installed over the entire area of the diaphragm
- Joints and fastener heads must be stopped. GIB® tape must be used in joints

6.2 GIB AQUALINE® WET AREA SYSTEMS

This section covers the installation of GIB Aqualine® Wet Area Systems. Full information can be found in the GIB Aqualine® Wet Area Systems literature.

GIB Aqualine®

GIB Aqualine®, with its green face paper, has a water resistant core which will provide resistance to the effects of moisture in wet areas such as bathrooms and laundries.

Although able to cope with infrequent short-term exposure, standard gypsum plasterboard will have a shortened life expectancy when frequently exposed to water or moisture.

The NZBC does not call for water resistant linings in wet areas but it is highly desirable to incorporate lining materials which will maintain their integrity longer when exposed more frequently to water or steam and particularly to one-off events such as leakages or flooding of a room.

Limitations

- Do not use GIB Aqualine® in situations where it is exposed for extended periods to humidities of 90% RH or greater. Such areas include group shower rooms, as well as moisture and chlorine laden environments such as indoor heated swimming pools
- GIB Aqualine® must not be installed in exterior situations
- GIB Aqualine® must not be directly applied to solid plaster (gypsum or cement) wood based sheet linings or similar materials, masonry or concrete. GIB Aqualine® may only be applied to these materials where timber strapping or steel furring channels are installed
- GIB Aqualine® must not be installed over a vapour barrier or a wall acting as a vapour barrier
- GIB Aqualine® must not be used for bracing purposes in shower cubicles or over baths

NZBC Clauses E3 Internal Moisture

E3.3.4 requires impervious and easily cleaned surfaces to all surfaces adjacent to sanitary fixtures or laundering facilities.

E3.3.5 requires that surfaces of building elements likely to be splashed or contaminated in the course of the intended use of the building, must also be impervious and easily cleaned.

E3.3.6 requires that surfaces of building elements likely to be splashed must be constructed in a way that prevents water from penetrating behind linings or into concealed spaces (e.g. wall cavities).

Walls in wet areas therefore need to be addressed according to whether they fall within the scope of one of the following descriptions:

1. Wall surface likely to be splashed
2. Wall surfaces directly exposed to water e.g. shower walls

Although not a requirement of NZBC it is highly recommended that the wall surfaces within 150mm of the top edge of a bath, and the vertical faces immediately under the edge of a bath, are treated in the same way as for a shower wall.

Alternative GIB® Plasterboard Options

For a list of permitted plasterboard substitution options for GIB Aqualine® refer to p14.

Scan to view GIB® installation videos



6.2.1 Surface in Showers and Around Baths

A waterproof membrane complying with AS/NZS 4858 MUST be applied to all lining materials used under ceramic tiles in these areas.

The waterproof membrane must extend to a 1500mm horizontal radius from a shower rose unless the shower is contained within a fixed enclosure. A shower curtain does not constitute a fixed enclosure.

Particleboard flooring manufacturers recommend that in wet areas, panels should be protected with a suitable wet area membrane or an integrally waterproof sheet material. Some local authorities call for this treatment on all timber based floors. Local requirements should be checked before proceeding.

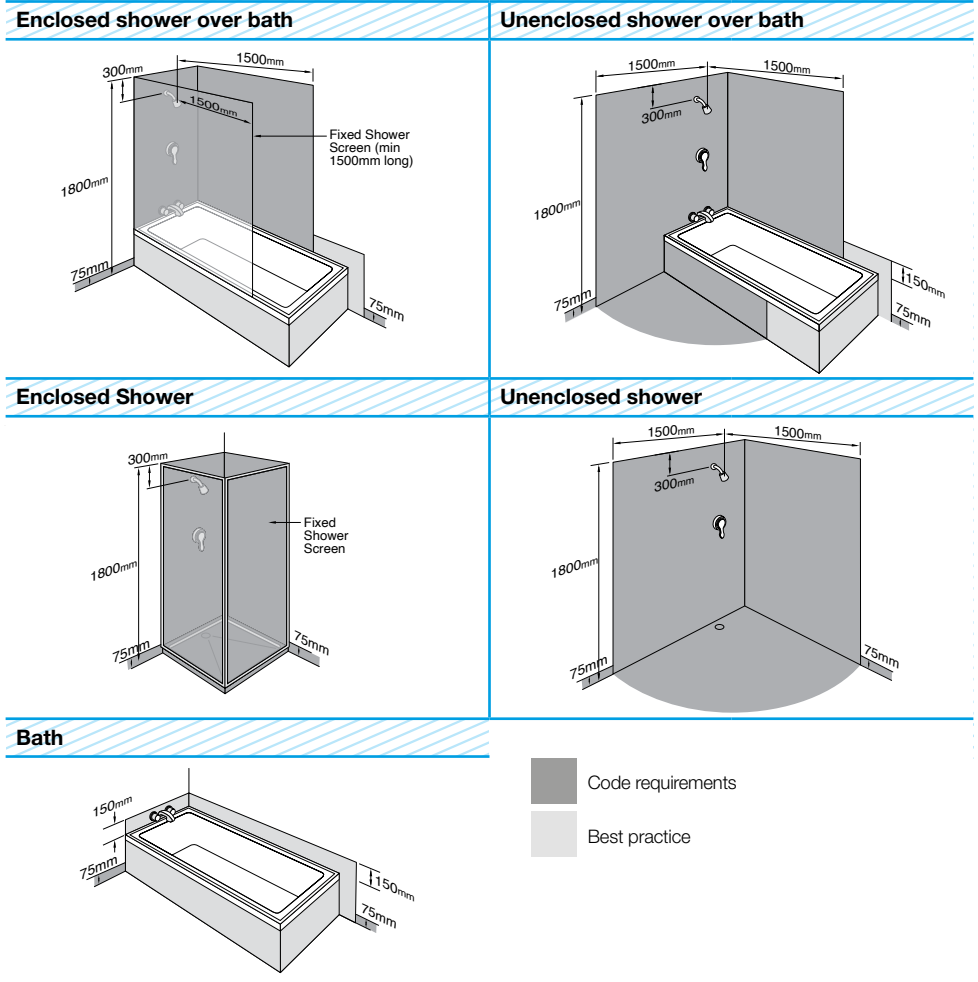

6.2.2 Fixing Details for Non Tiled Walls

As for general installation details (see p.41-44)

Ceilings

Fixing as for GIB® Standard plasterboard (see p.48)

6.2.3 Fixing Details for Tiled Walls

Wall Framing

Timber Framing dimensions and spacings must comply with the requirements of NZS 3604:2011.

Prior to lining in tiled areas (shower cubicles and shower over bath only) the internal corners should be reinforced with a minimum 32mm x 32mm angle such as NZ18 or GIBFix® Angle. Each side of the angle should be fastened to the framing with 30mm galvanised clouts at 300mm max centres (see p.80).

Steel stud systems are proprietary but do not generally incorporate nogs except as required below:

- Adjacent to each pipe penetration and behind sink and tub flashings
- Between all studs above bath flanges and preformed shower bases
- To support towel rails, grab rails and wall basin brackets
- For impact protection in shower cubicles or shower over bath situations it is important that all sheet joints are made on solid blocking. This may either require vertical fixing of the GIB Aqualine® or the installation of some additional nogs

Jointing

All sheet joints must be GIB® tape reinforced and stopped in accordance with instructions on p.91.

Lining and Tile Weights

- For 10mm GIB Aqualine® use min 25mm x 6g GIB® Grabber® Drywall Screws
- For 13mm GIB Aqualine® use min 32mm x 6g GIB® Grabber® Drywall Screws
- GIB Aqualine® may be fixed vertically or horizontally
- Provide a 5mm–10mm gap at the wall/floor junction
- Provide a 5mm–10mm gap between the bottom edge of the GIB Aqualine® and any bath rim or preformed shower base to allow for placement of sealant
- GIB Aqualine® sheets should be touch fitted
- Where the framing or fastener centres required for tiled GIB Aqualine® are closer than those specified for GIB® Fire Rated and GIB Noise Control® Systems, the GIB Aqualine® specification will prevail. Where relevant check fastener lengths comply with requirements of GIB® Fire Rated Systems
- Do not fix tiles to GIB® plasterboard ceilings or non-vertical planes

Jointing

- Jointing must be carried out in accordance with instructions on p.93
- No joint compound is required under impervious shower linings
- Air drying compounds shall not be used on areas that are to be tiled

Maximum Tile Weights for GIB Aqualine®, GIB Toughline® Aqua or GIB Weatherline®

Stud Centre (max)	Fasteners Centre (max)	Lining Thickness	Tile Weight
600mm max	150mm max	10mm	26kg/m ²
		13mm	40kg/m ²

Scan to view GIB® installation videos



Horizontal Fixing

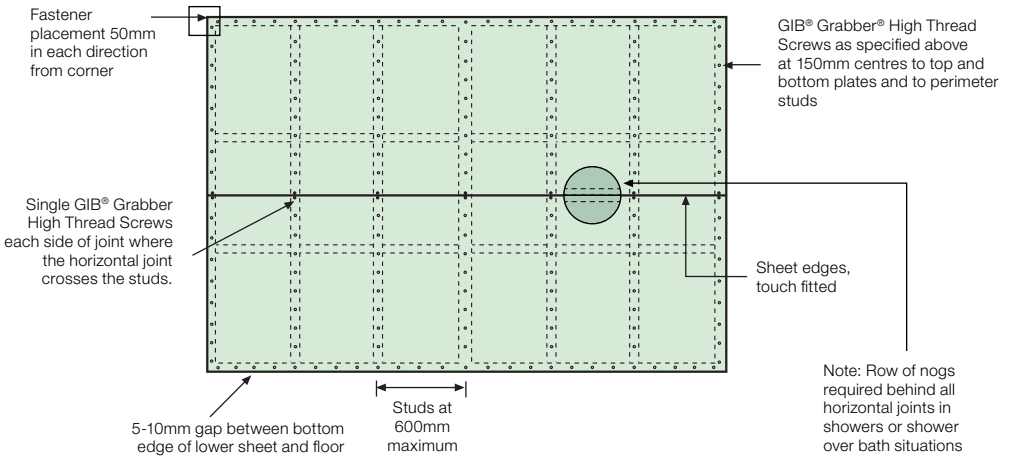

Vertical Fixing

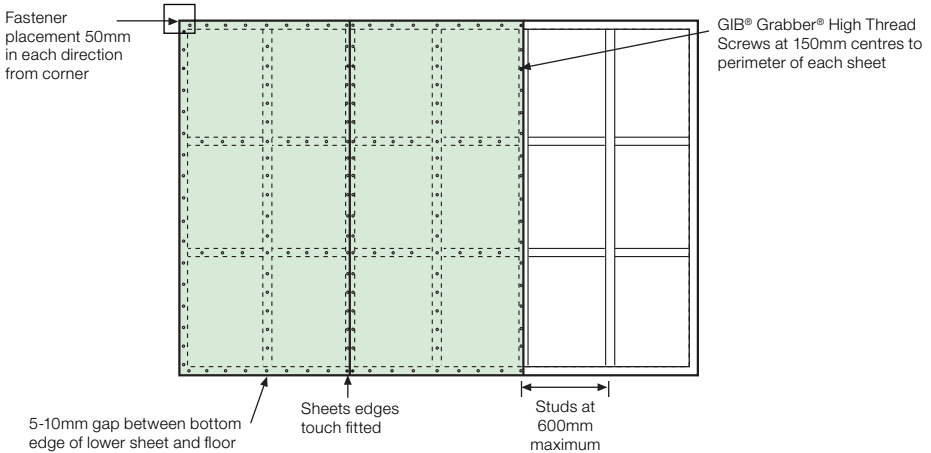

6.2.4 Metal Angles for Tiled Internal Corners

- Prior to lining in tiled areas (shower cubicles and shower over bath only) the internal corners shall be reinforced with a minimum 32 x 32 x 0.55mm galvanised metal angle
- Suitable GIB® metal angle options include:
 - GIB® Rondo® NZ18 metal angle, available length: 3.0m

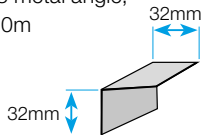

- GIBFix® Angle metal angle, available lengths: 2.4m and 2.7m

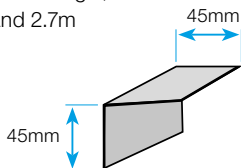

- Angles need to be temporarily held in place until secured by the lining fixings
- Minimum height of the metal angle is 1800mm

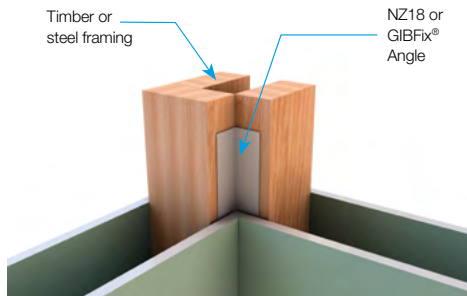

Waterproof Membrane Systems

A waterproof membrane system must be applied to all lining materials used as a substrate for ceramic tiles in a shower or shower over a bath

application, or any other tiled application exposed to frequent water splash.

Tiles and Tile Weights

In areas likely to be directly exposed to water, tiles may be ceramic, porcelain or stone must comply with the over-surface finish requirements of the IWAM Code of Practice and be bedded with a suitable tile adhesive on the waterproof membrane system. See page 77 for the minimum extent of wall surfaces requiring impervious sheet materials or waterproof membrane systems prior to tiling.

Smaller mosaic tiles are often lighter, but the integrity of grout joints might be more prone to impact, whilst heavier tiles are larger and have less and deeper grout and sealant joints. For more information also see AS 3958:2007 Ceramic tiles – Guide to the installation of ceramic tiles.

Adhesive and Grout Weights

The weight of adhesive and grout can vary depending on the type of tile and the installation process used. The maximum tile weights stated in the table opposite are conservative and refer to the tile weight excluding grout and adhesive used. An additional 3kg/m² has been factored into tile adhesion testing on top of the above stated tile weights to account for adhesive and grout weight used during the installation of the tile.

Maximum Tile Weights for GIB Aqualine®, GIB Toughline® Aqua or GIB Weatherline®

Stud Centre (max)	Fasteners Centre (max)	Lining Thickness	Tile Weight
600mm max	150mm max	10mm	26kg/m ²
		13mm	40kg/m ²

6.2.5 Tiling, Flexible Sheet Vinyl and Rigid Sheet Shower Linings

Tiling

- Tile grouting and sealing must be carried out in accordance with the requirements of AS3958.1 2007 (Guide to the Installation of Ceramic Tiles)
- Provide for surface control joints at 4m centres maximum
- The adhesive must be organic based complying with AS2358 – 1990 (Adhesives for Fixing Ceramic Tiles)
- Note that the adhesive should be combed in a horizontal direction only. It is important that adhesive is applied to the wall and not “buttered” onto individual tiles

Flexible Sheet Vinyl – Showers and Other Wet Areas

- GIB Aqualine® is a suitable substrate for flexible vinyl wall finishes in wet areas of residential, commercial or institutional buildings
- Framing requirements and installation procedures for the GIB Aqualine® substrate must be as per p.78, except that the lining gap at the floor is reduced to 5mm when a pencil cove detail is used
- The installation of metal reinforcing angles (minimum. 32 x 32 x 0.55mm) behind internal GIB Aqualine® corners is recommended for sheet vinyl applications in showers or shower over bath situations (see illustration p.82)
- The GIB Aqualine® lining must be jointed and stopped to a paint quality finish (Level 4) – trowel marks can telegraph through even a commercial grade 2mm vinyl
- A minimum vinyl thickness of 2mm is recommended for the wall finish in commercial or institutional bathrooms and showers
- In areas directly exposed to liquid water, all joints in flexible sheet vinyl must be heat welded
- Installation of the flexible vinyl must be carried out strictly in accordance with the specifications provided by the suppliers/manufacturers of the vinyl

Rigid Sheet Shower Linings

- The manufacturers/suppliers of thin (usually 2mm–3mm) and rigid acrylic shower linings commonly recommend direct adhesive fixing to wall linings using solvent-based adhesives
- Do not pre-seal areas which are to be covered by the rigid shower linings
- Some suppliers of rigid sheet acrylic shower linings recommend a minimum of one week for the adhesive to cure fully prior to use
- Water temperature changes will cause movement of the thin acrylic sheet, which in turn will stress the adhesive and wall lining substrate
- Care must be taken to ensure that rooms are adequately ventilated and the adhesive is fully cured before the shower is used
- Consult the manufacturer/supplier of the shower lining for full installation details

Waterproof Membranes (tiled shower areas and shower over baths)

- In showers and shower over bath situations the GIB Aqualine® system is not complete and ready for tiling until coated with a waterproof membrane over the lining and the jointed areas
- Only in-situ waterproofing materials which are manufactured to AS/NZS 4858:2004 Wet Area Membranes Requirements are recommended.
- Waterproof membranes must be fully cured and dry prior to application of tiling adhesives
- Embed reinforcing mats in the membrane at all internal corners of the shower (including floor/wall junctions)

For further information on waterproof membranes prior to tiling, consult BRANZ GOOD PRACTICE GUIDE TILING.

FIG. B: Typical Details for Tiled Shower over Bath

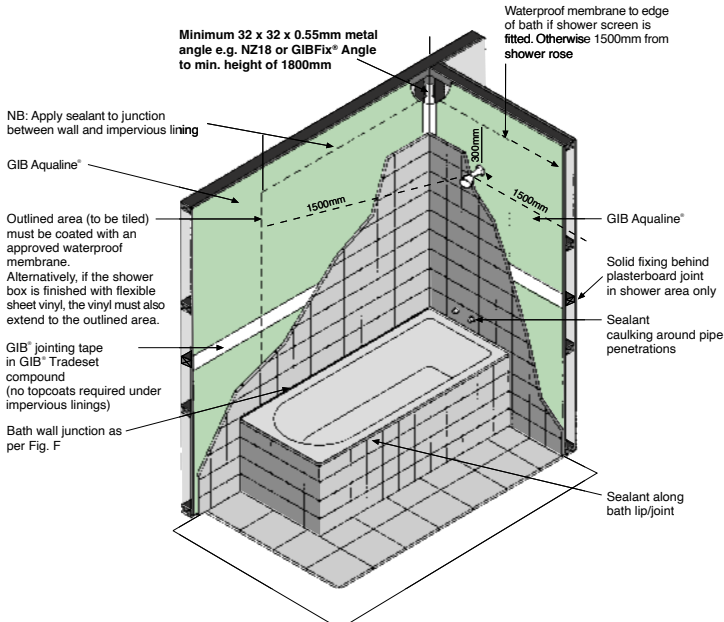

FIG. C: Typical Details for Tiled Shower Enclosure

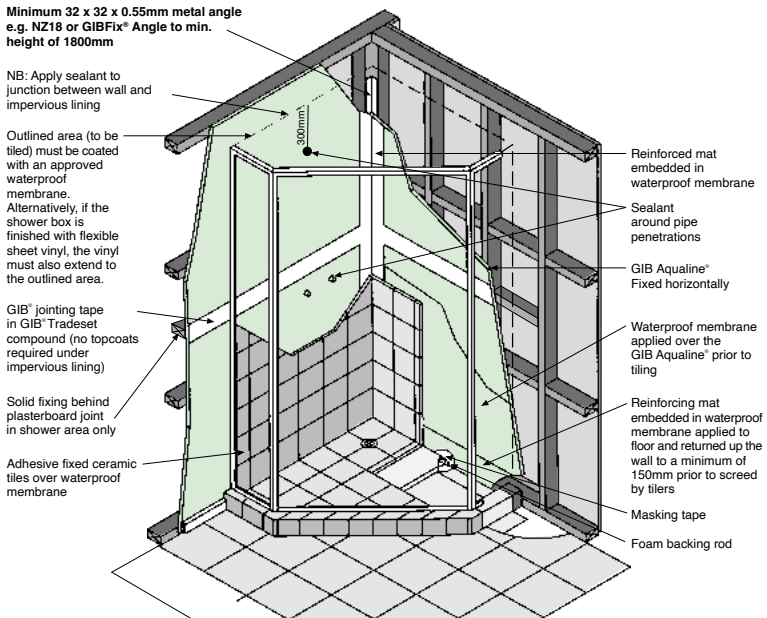

FIG. D: Typical shower edge detail

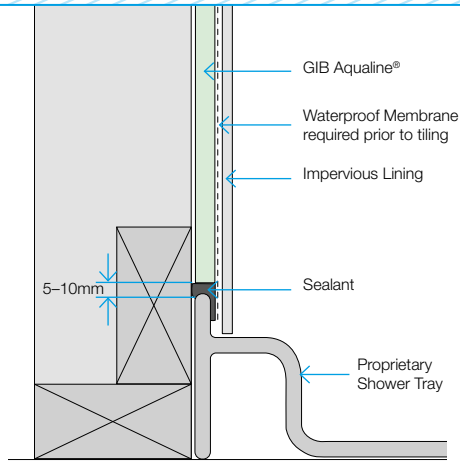

FIG. E: Typical shower edge detail in fire or noise control area

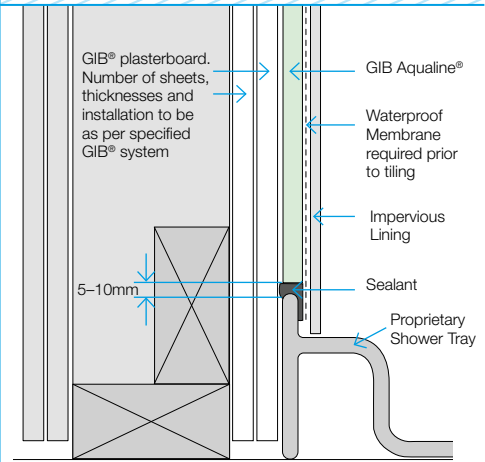

FIG. F: Typical bath edge detail

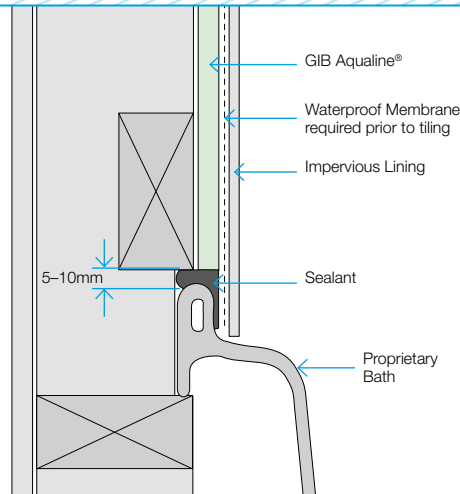
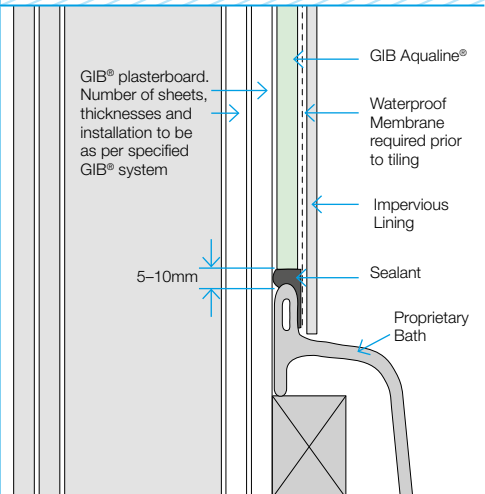

FIG. G: Typical bath edge detail in fire or noise control area



As the edge profiles of showers and baths can vary significantly between manufacturers, these details are intended only as a guide. Attention should be paid to ensure that:

- Sufficient sealant to effect a waterproof barrier has been used
- The sealant has been applied in a manner that does not permit water ingress

Note: The gap between the front face of the shower/bath upstand and the front face of the GIB Aqualine® should be 1mm–4mm. This may require additional packing behind final layer of GIB Aqualine® OR checking shower tray or bath into framing.

Silicone sealants must be of the mould inhibiting type and must be compatible with GIB Aqualine®, shower/bath surfaces and the impervious lining.

6.2.6 Typical Construction Details

It is recommended that GIB Aqualine® is fixed to ceilings in wet areas such as bathrooms and

laundries. Installation is the same as for standard ceiling. See p.48.

FIG. H: Typical Plumbing Penetration

Penetrations in wet areas should be sealed with silicon sealant to prevent moisture access to the framing.

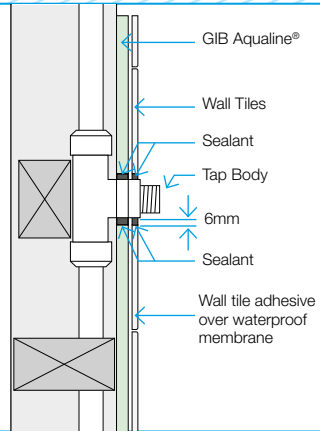

FIG. I: Sealing Under Mixer Facia

Apply a bead of sealant behind the cover plate on shower mixer to divert any water from the penetration.

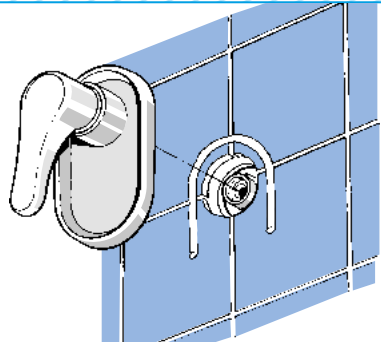

FIG. J: Tiled Shower – Internal Corner Detail

Edge profiles of baths and shower trays can vary significantly between manufacturers. Always follow the manufacturers installation instructions.

The details shown are intended as a guide only.

Allow 5mm–10mm gap between bath rim and/or shower base to allow for installation of sealant.

Sealants should contain a mould inhibitor.

Ensure that the gap is well filled with sealant.

Minimum 32 x 32 x 0.55mm metal angle e.g. NZ18 or GIBFix® Angle to min. height of 1800mm

GIB Aqualine®

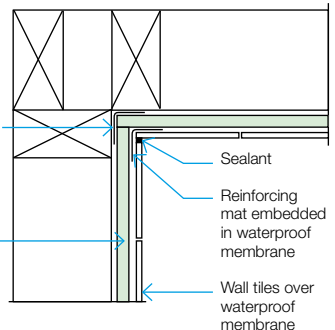

6.3 GIB® FIRE, NOISE AND OTHER PERFORMANCE SYSTEMS

Because of the volume of information it is not feasible to include installation guidance for all the GIB® Performance Systems in the GIB® Site Guide. If you are installing GIB® Performance Systems including GIB® Fire, Noise, Tough, Rigid Air Barrier or Intertenancy Barrier systems it is strongly recommended that you obtain a copy of the relevant specification and installation publication prior to commencing installation.

These can be easily accessed by:

- Download from gib.co.nz
- Download the GIB® App available free from the App or Google Play Stores
- Contact the GIB® Helpline on 0800 100 442
- Or from most GIB® plasterboard stockists

6.3.1 GIB® Fire Rated Systems

The NZBC requires fire safety systems to reduce the risk of injury or death, and to protect adjacent property in a fire situation.

Fire rated systems require attention to the details in the GIB® Fire Rated Systems literature.

Deviating from these specifications can invalidate the system leading to expensive remedial work to comply or increased risk in case of fire.

A fire system is NOT simply a matter of fixing GIB Fyreline® instead of another GIB® plasterboard.

The fire resistance rating can only be assured when the board has been installed strictly in accordance with the relevant instructions in the GIB® Fire Rated Systems literature.

6.3.2 GIB Noise Control® Systems

Noise control for Intertenancy situations is comprehensively covered in GIB Noise Control® Systems literature. As these situations are generally subject to building code requirements, it is important that the publication is consulted to design and construct Intertenancy noise control systems.

Sound Transmission Class (STC)

STC relates to airborne noise such as speech, TV and so on. It is the ability of a wall, ceiling, or floor/ceiling to reduce noise from rooms next door. In general a higher STC means a better performance.

STC 35 – Normal speech may be clearly heard in the next room

STC 45 – Muffled speech may be heard in the next room

STC 55 – Minimum building code requirement for intertenancy walls

Impact Insulation Class (IIC)

IIC measures the ability of a floor or ceiling system to reduce noise resulting from impacts such as footsteps, falling objects and moving furniture. A higher IIC means a better performance. Impact noises easily travel from hard surfaces into the structure and to the room below. Hard surfaces such as finished timber floors and ceramic tiles often cause noise transmission to the room below. Semi-hard surfaces such as cork tiles and flooring grade vinyl perform a little better, but still do not efficiently absorb impact energy. Installing carpet and underlay is an effective way of reducing impact noise. Installing a GIB Noise Control® System will help reduce impact and airborne noise levels.

Scan to view GIB® installation videos

