



GIB®

Site Guide

For Residential and
Commercial Installations.

CBI 5113

APR 2024

RRP \$9.95 ^{INST}/_{EST}





ABOUT WINSTONE WALLBOARDS

At Winstone Wallboards Ltd we are passionate about providing quality GIB® products, systems and expert technical support to help make it a little easier, quicker and simpler for our customers to create great interior living environments both now and for generations to come.

GIB® plasterboard, locally made for over 95 years and counting.

GIB® Help Line – Call Free

0800 100 442

Email

info@gib.co.nz

Website

gib.co.nz

The names GIB®, GIB Fyreline®, GIB Ultraline®, GIB Barrierline®, GIB Braceline®, GIB Toughline®, GIB Weatherline®, GIB Toughline®Aqua, GIB Noiseline®, GIB Aqualine®, GIB Tradeset®, GIB Plus 4®, GIB-Cove®, GIB Lite Blue®, GIB Tradefilla®, GIB Fix®, GIB RocTape®, GIB Wideline®, GIB Trade Finish®, GIB® RediFilla™, GIB TradeFilla®, GIB LiteSet®, the colour mauve for GIB Toughline®, the colour blue for GIB Braceline® / GIB Noiseline®, the colour pink for GIB Fyreline®, the colour green for GIB Aqualine®, and the shield device are registered trademarks of Fletcher Building Holdings Limited.

Copyright © Winstone Wallboards Ltd 2024

USE ONLY THE CURRENT SPECIFICATION

This publication may be superseded by a new publication. Winstone Wallboards Ltd accepts no liability for reliance upon publications that have been superseded.

Before using this publication check whether this is the current publication; simply call the GIB® Helpline on 0800 100 442 or visit gib.co.nz

PUBLICATION TERMINOLOGIES USED

The terms “should” and “must” are used throughout this publication.

Should

- Is used where Winstone Wallboards is recommending best industry practice.

Must

- Is used where NZ Building Code requires a specific action to be undertaken.

GIB® Warranty Statement



WE ARE 100% BEHIND OUR PRODUCTS AND SYSTEMS

If any of our products or systems* fail to perform as claimed or an issue associated with any GIB® product or system does occur, Winstone Wallboards will work with the relevant parties to help resolve the issue.

SYSTEM AND PRODUCT COMPONENTS

A system is a group of related product components that interact to perform a task. Ensure the full GIB® building system, including the appropriate GIB® branded products, are specified and installed. This will ensure performance is not compromised and that any failure that is attributable to GIB® products and/or systems will be supported. Winstone Wallboards will not support system performance where substitute products are used.



BRANZ Appraised
Appraisal Nos. 427 [2021],
289 [2018], 340 [2022],
928 [2021], 394 [2017],
1048 [2019]

YOU'RE PROTECTED WITH GIB® PLASTERBOARD SYSTEMS**

Since 1927 building professionals have relied on GIB® plasterboard systems. Locally made for local conditions, they meet or exceed the New Zealand building code, are BRANZ appraised and are backed by full technical information and support to give complete confidence in using GIB® plasterboard systems*.



*When installed and maintained strictly in accordance with the relevant Winstone Wallboards literature current at the time of installation and under normal conditions of dry internal use.

PRODUCT AND SYSTEM WARRANTY**

The Winstone Wallboards warranty covers GIB® products and/or systems for a minimum of 10 years from the date of purchase. Winstone Wallboards warrants that GIB® products will be free from defects caused by factory workmanship or materials and, subject to compliance with the conditions in the Winstone Wallboards warranty statement, that the product or system will perform to the extent set out in relevant Winstone Wallboards published literature current at the time of installation. Nothing in this document will exclude or modify any legal rights a customer may have under the Consumer Guarantees Act or otherwise which cannot be excluded or modified at law.

NZ BUILDING CODE CLAUSE B2 – DURABILITY

The Building Code sets the required durability standard for specific elements of building work. Clause B2 Durability aims to ensure that building elements and buildings are durable enough so all other objectives of the Building Code are satisfied throughout the life of the building, without the need for reconstruction or major renovation.

GIB® SYSTEMS DURABILITY

The following systems have, unless stated otherwise in the technical literature, a serviceability life in excess of that stated and satisfy the requirements of NZBC Clause B2 Durability.

15 Years

- GIB Aqualine® Wet Area Systems
- GIB Weatherline® Rigid Air Barrier Systems***

50 Years

- GIB® Fire Rated Systems
- GIB EzyBrace® Systems
- GIB X-Block® Systems
- GIB Noise Control® Systems
- GIB® Intertency Barrier Systems

**Visit gib.co.nz/warranty to view the full GIB® products and systems warranty including terms and conditions.

***50 years where cladding durability requirements is 50 years



Site Guide: Table of Contents

1.0	INTRODUCTION	4
1.1	GIB® Systems Literature	4
1.2	GIB® Products and Systems	4
1.3	Substitution	4
1.4	Achieving the Desired Finish Quality	4
1.4.1	Levels of Finish	4
1.4.2	Levels of Finish Selection Chart	5
1.4.3	Levels of Finish Guidelines	6
1.4.4	Assessment Of The Finished Surface Condition At Handover To End Users	7
1.4.5	Critical Lighting	8
1.4.6	Other Factors that Influence the Finished Surface	8
1.5	Health and Safety	9
1.6	Compliance	9
1.7	Limitations	9
1.8	Complaints Procedure	9
2.0	GIB® PRODUCT RANGE	10
2.1	GIB® System Manuals	10
2.2	GIB® Plasterboard Range	12
2.3	GIB® Plasterboard Alternatives	14
2.4	GIB® Fasteners	15
2.5	GIB Barrierline® Components	16
2.6	GIB Weatherline® Components	17
2.7	GIB® Rondo® Metal Batten Ceiling System	18
2.8	GIB® Adhesives and Sealants	20
2.9	GIB-Cove®	20
2.10	GIB® Compounds	21
2.11	Change Compounds for Different Seasons	24
2.12	GIB® Paper Faced Trims	25
2.13	GIB® Metal Trims	26
2.14	Control Joints	27
2.15	GIB® Additional Components	28
3.0	SUSTAINABILITY	29
3.1	Waste Minimisation	29
3.2	Plasterboard Offcut Recycling Services	29
4.0	PRE – INSTALLATION	30
4.1	Delivery Options	31
4.1.1	DTS Standard Delivery Options	31
4.1.2	Specialised Delivery Options	31
4.2	Is Your Site Plasterboard Ready	32
4.3	Site Conditions	33
4.4	Stacking, Storage and Handling	33
4.5	Protection from Weather	34
4.6	Ordering and Delivery	34
4.7	Timber Moisture Content	34
4.8	Site Health and Safety	34
4.9	Required Tools	35
5.0	GENERAL WALL AND CEILING INSTALLATION	36
5.1	Before Starting Installation	36
5.2	General Installation Technique	37
5.3	GIB® Plasterboard Installation – Walls	41
5.3.1	Timber Frame – Horizontally Fixed	41
5.3.2	Timber Frame – Vertically Fixed	42
5.3.3	Steel Frame – Horizontally Fixed	43
5.3.4	Steel Frame – Vertically Fixed	44
5.3.5	Fastening to Metal Studs	45

5.3.6	Grooved Jambes and Architraves	46
5.3.7	Reducing Joints When Using Grooved Jambes	47
5.4	Installation to Ceilings	47
5.4.1	General Installation	47
5.4.2	Standard Ceiling Fixing	48
5.4.3	Raking Ceilings and Skillion Roofs	49
5.4.4	Back Blocking – Butt and Edge Joints	50
5.4.5	Control Joints – Walls and Ceilings	51
5.4.6	Control Joint Installation Details	52
5.4.7	GIB® Rondo® 310 Metal Batten System Installation Instructions	54
5.4.8	GIB® Rondo® 308 Metal Batten System Installation Instructions	56
5.4.9	GIB® Rondo® Suspended Ceiling System	58
5.5	Curving GIB® Plasterboard	59
5.6	Fixing to Masonry	60

6.0 GIB® PERFORMANCE SYSTEMS 62

6.1	GIB® Bracing Systems	62
6.1.1	Installation Summary - Internal System Options	63
6.1.2	Internal Bracing System Specifications	64
6.1.3	Installation Summary - Exterior System Options	66
6.1.4	Exterior Bracing System Specifications	67
6.1.5	Bottom Plate Fixing	69
6.1.6	Panel Hold-Down Details	69
6.1.7	GIB Ezybrace® Fastener Pattern	71
6.1.8	General Installation Details	72
6.1.9	Ceiling Diaphragms	74
6.2	GIB Aqualine® Wet Area Systems	76
6.2.1	Surface in Showers and Around Baths	77
6.2.2	Fixing Details for Non Tiled Walls	78
6.2.3	Fixing Details for Tiled Walls	78
6.2.4	Metal Angles for Tiled Internal Corners	80
6.2.5	Tiling, Flexible Sheet Vinyl and Rigid Sheet Shower Linings	81
6.2.6	Typical Construction Details	82
6.3	GIB® Fire, Noise and Other Performance Systems	85
6.3.1	GIB® Fire Rated Systems	85
6.3.2	GIB Noise Control® Systems	85

7.0 JOINTING AND FINISHING SYSTEMS 86

7.1	Jointing – Materials	86
7.2	Determining How Much You Need	87
7.3	Weather and Ventilation	88
7.4	Identifying Product Use By Dates	90
7.5	Stopping of Tapered or Recessed Edge Joints – Hand Tools	91
7.6	Jointing Techniques – Hand Tools	92
7.7	Stopping of End Joints / Butt Joints and Cut Edges – Hand Tools	94
7.8	Jointing Techniques – Mechanical Tools	95
7.9	Nail and Screw Stopping	98
7.10	Corners and Finishing Trims	98
7.11	Square Stopping	98
7.12	Negative Detail	100
7.13	Timber Scotia	100
7.14	GIB-Cove®	101
7.15	Skim Coating	103
7.16	Sanding	104
7.17	Joint Systems Recommendation	105
7.18	Painting	107

8.0 REPAIRS AND MAINTENANCE 108

8.1	Plasterboard Repairs	108
8.2	Mounting Fixtures to GIB® Plasterboard	112

9.0 GIB® TROUBLESHOOTING 113



1.0 INTRODUCTION

The planning, building and finishing of a home or commercial building has a large number of important considerations. This guide provides you with the essential information needed when designing with, and/or installing, GIB® systems.

GIB® systems specifically designed for fire rating, rigid air barrier, noise control, bracing and wet areas are not fully documented in this guide. Please refer to the relevant sections in the specific technical publications.

1.1 GIB® SYSTEMS LITERATURE

Winstone Wallboards offers an extensive range of tested systems to ensure compliance with the requirements of the New Zealand Building Code.

Detailed information about these systems can be found in GIB® systems literature (see p.10–11).

1.2 GIB® PRODUCTS AND SYSTEMS

GIB® systems incorporate different GIB® products, which are manufactured or supplied by Winstone Wallboards and are distributed nationwide by authorised dealers.

Winstone Wallboards has a range of GIB® branded jointing compounds, adhesives, fasteners and other drywall products. It is recommended that these GIB® branded products are used with GIB® plasterboard systems.

They have been specifically developed or chosen by Winstone Wallboards for their compatibility with GIB® plasterboard systems.

Refer to the installation section for instructions on how to handle, store, install, fix and maintain GIB® products and systems. These instructions must be followed if GIB® systems are to achieve their claimed performance levels.

1.3 SUBSTITUTION

Winstone Wallboards accepts no liability if the systems are not installed in accordance with instructions contained in the GIB® technical literature. Substitution of specified or recommended components with alternative brands can compromise performance.

If alternative products are substituted into GIB® Systems it is the responsibility of the user to ensure that the performance of the system is not compromised.

1.4 ACHIEVING THE DESIRED FINISH QUALITY

No matter how smooth wall and ceiling linings may appear, they will never be 100% physically flat. It is possible however to achieve the 'appearance' of blemish free flatness with the

appropriate choice of a number of factors. For more detail refer to the 'GIB® Interior Finishing' literature. Download from gib.co.nz or call 0800 100 442 for a copy.

1.4.1 Levels of Finish

Having a clear understanding of the Levels of Finish is an important step in delivering an acceptable finished surface.

- Levels of Finish are a set of guidelines contained in AS/NZS 2589:2017 for specifying the required quality of finish prior to the application of decorative finishes such as paint
- No sheet lining material or substrate has a surface that is perfectly flat and totally free of minor imperfections
- It is important to be aware that Levels of Finish apply only to the finished plasterboard

surface PRIOR to the application of any paint or decorative systems

Often there is a gap between the finish that a customer expects and the finish that can realistically be delivered. There are several factors that influence the final finished appearance. These include:

- Natural or artificial light from a critical angle
- Installation techniques and workmanship
- Stopping techniques and workmanship

Three Levels of Finish are defined in AS/NZS 2589:2017.

Level 3 — Level 3 must be used in areas that do not require decoration, such as above ceiling level or inside service shafts and the like.

All joints and interior angles must have tape embedded in joint compound and one separate coat of joint compound applied over all joints and fastener heads. All joint compounds must be finished smooth. (Generally this is achieved by scraping off nibs and ridges and the like, with the edge of a trowel.)

Level 4 — Level 4 is the default level of finish for gypsum linings unless specified otherwise.

Flat or low sheen paints must be used for this level.

All joints and interior angles must have tape embedded in jointing compound and a minimum of two separate coats of jointing compound applied over all joints, angles, fastener heads and accessories. All jointing compound must be finished evenly and be free of tool marks and ridges in preparation for decoration.

Note:

- Under critical lighting conditions surface imperfections may still be apparent in a Level 4 finish.

Level 5 — Level 5 is for use where gloss or semi-gloss paints are specified or where critical lighting conditions occur on flat or low sheen paints. Level 5 is characterised by a parity of texture and porosity. The surface texture must be random in fashion and monolithic, concealing joints and fixing points.

All joints and interior angles must have tape embedded in joint compound plus a minimum of two separate coats of joint compound applied over all joints, angles, fastener heads and accessories. All joint compound must be finished smooth and be free of tool marks and ridges.

A paint or plaster material is to be sprayed, rolled or trowelled over the defined area in accordance with the manufacturers recommendations.

Note:

- Level 5 is difficult to achieve and always requires co-operation of the framer, plasterboard installer, plasterer and painter in establishing suitable work practices that deliver the agreed paint finish for the given project
- Some minor imperfections may still be visible in a Level 5 finish, however these will be minimised under the additional measures applied under Level 5
- The surface of the defined area may require sanding to be suitable for decoration

1.4.2 Levels of Finish Selection Chart

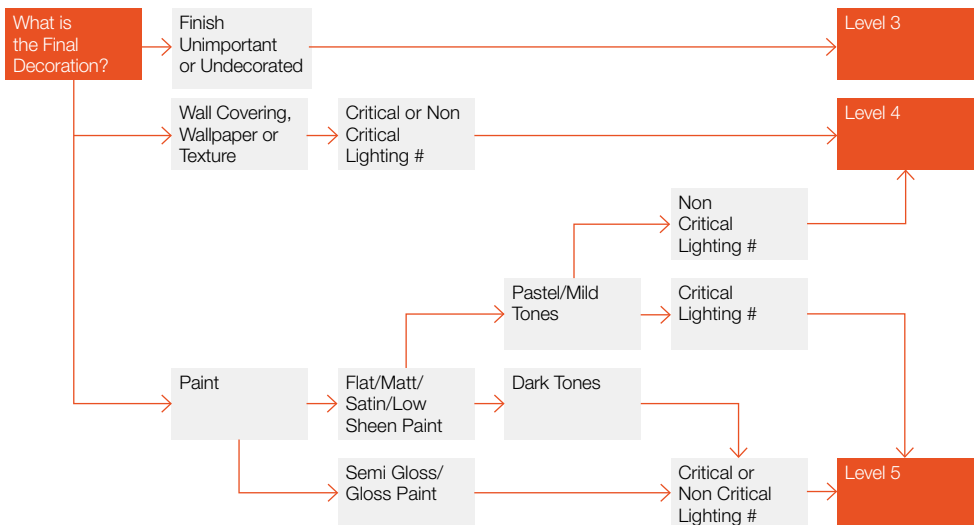

May not be suitable for subsequent decoration to high levels of quality in the future. Refer to Level 4 or 5 for upgrading requirements.

Critical lighting – when the light source is nearly parallel to the surface.

Non critical lighting – when the light striking the surface is diffused and / or at right angles

1.4.3 Levels of Finish Guidelines

For light timber framed construction as extracted from AS/NZS 2589:2017.

Note: It is important to recognise that the Level of Finish approach was developed to optimise

installed plasterboard surfaces IN PREPARATION for decoration and NOT as a basis for establishing acceptance or rejection criteria for the final decorated surface.

Levels of Finish Guidelines			
	Level 3	Level 4	Level 5
Framing Requirements			
Maximum deviation from a 1800mm straight edge along or across adjacent framing members	90% of measured points must be less than 4mm. 10% may be no more than 5mm.		90% less than 3mm. 10% no more than 4mm.
Timber moisture content at the time of lining	18% or less.		
	NZS 3602 recommends lower moisture content (8% - 18%) if heat pumps, air conditioning or central heating are to be installed.		
Installation Requirements			
Wall joints	Sheets must be set out to minimise joints, usually requiring wall sheets to be horizontally fixed.		
Joints round openings	Vertical joints must not coincide with the vertical edge of doors or windows. If a joint needs to be made in this area it must be made above the opening, no closer than 200mm to the edge of the opening.		
Control joints	Control joints must be positioned at maximum 12.0m centres in either direction. See p.51		
Sheet and butt joints in ceilings	These must be made centrally between ceiling battens and back blocked. Butt joints should be staggered by at least 600mm.		
Sheet end butt joints in walls	Can be made on framing or back blocked between studs.		All joints must be back blocked.
Tapered edge joints in ceilings	Back blocking not required but is still highly recommended.	Must be back blocked in areas with 3 or more sheet edge joints on timber battens (6 if metal battens have been used) Not required in ceiling suspension systems. See p.50	All joints must be back blocked.
Finishing Requirements			
Joints	All joints must have GIB® jointing tape embedded in joint compound PLUS 1 additional coat of joint compound applied over all joints, angles, accessories and fastener heads.	All joints must have GIB® jointing tape embedded in joint compound PLUS 2 additional coats of joint compound applied over all joints, angles, accessories and fastener heads.	
Additional requirements			A skim coat must be applied to remove differential surface porosity.
*Tapered edge joint total width (incl. formed tapers in backblocked sheets).	170mm min.	250mm min.	
*Butt joint widths (flat joints)	340mm min.	500mm min.	
*Joint build-up	Maximum of 2mm build up across entire width as an even curve, without a distinct peak or ridge. Joint should not be hollow.		
*Joint surface (incl. internal and external corners)	No gouges, scratches, voids, pock marks or tool marks. Joint edges should be smooth and feathered without any scuffed paper. Edges should be an even straight line.		
*External angles	Must be plumb and straight. Minimum joint width 250mm. 3mm max build up at the metal angle over an even, gentle taper. Joint should not be hollow.		
*Internal angles	Must be plumb and straight. Minimum joint width 100mm. 2mm max build up at the corner, over an even, gentle taper. Joint should not be hollow.		

This chart is intended as a guide only to critical elements relating to Levels of Finish.

Full details of the requirements can be found in AS/NZS 2589:2017

*These minimum requirements have been extracted from AS/NZS 2589:2017

1.4.4 Assessment Of The Finished Surface Condition At Handover To End Users

A satisfactory finish for plasterboard linings is dependent on a number of critical factors including the straightness of the underlying substrate to which they are attached. Careful management of localised build-up of joint compound on the surface of plasterboard linings during the finishing process of jointing, internal and external angles and fastener points is also required.

This clause is to be used to assess the finish of joints, angles and fastener points in plasterboard wall or ceiling linings, or both.

Visual satisfaction of the final job can be impacted by the quality of finished decoration. A sign-off form should be used at handover to assist in agreement between the parties on the quality of finish to avoid concerns being levelled at the finish of the plasterboard lining when it may relate to inadequate decoration.

Note: High intensity lighting is commonly used to provide light for work areas or application purposes but is not deemed suitable for performing a subjective visual inspection of interior surfaces. Inspection should be undertaken under normal lighting conditions (in the absence of critical lighting) and from normal viewing positions. See diagram below.

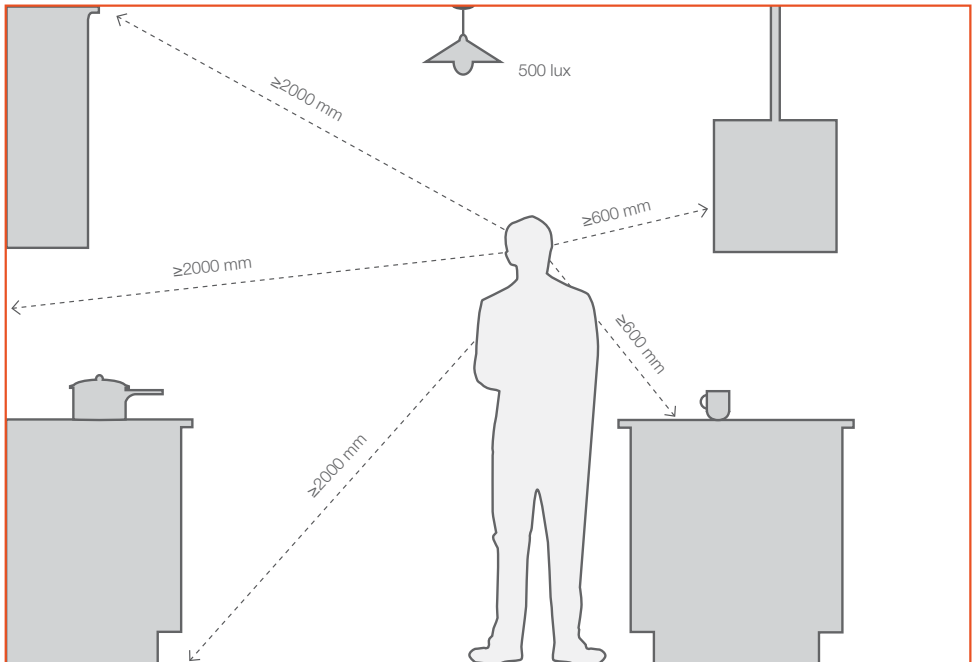

Normal viewing positions vary depending on the type of surface being inspected.

Taken from MBIE Guide to tolerances, materials and workmanship in new residential construction 2015.

1.4.5 Critical Lighting

When light from sources such as windows, skylights and artificial wall or ceiling washer lights strike a surface at a shallow angle surface, irregularities tend to be exaggerated. This is termed

“critical lighting”. When the angle of light is more or less at right angles to a surface, imperfections are less obvious – this is termed “non-critical lighting”.

Minimising Critical Lighting

- Horizontal Fixing – fix GIB® plasterboard sheets horizontally instead of vertically on walls. GIB® plasterboard fixed horizontally allows glancing light from adjacent windows to shine along the joint reducing the “shadowing” effect that can be more noticeable with vertical fixed. Refer to Figures 1 and 2
- Sheet layout is often determined by the system being installed. Ensure that the sheet layout complies with the installation requirements of the particular system.
- Recessed downlights and light shades – incorporating recessed downlights or light shades help to channel light downwards. Refer to Figures 3, 4 and 5
- Spot Lights – avoid spot lighting or wall mounted up-lighting or be careful about where these lights are directed and the angle at which they hit a surface particularly near jointing
- Window Positioning and Shades – avoid positioning narrow windows hard up against the end of a wall or ceiling, particularly on long walls or ceilings at the end of a room or hallway. Making a window wider and placing it away from the room corner should reduce the critical lighting effect. Avoid taking windows right up to the ceiling level. Provide sunshades over the window or recess the window to stop the sunlight reaching the wall. Refer to Figure 6

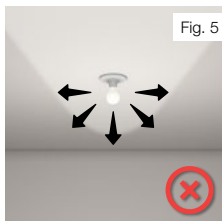
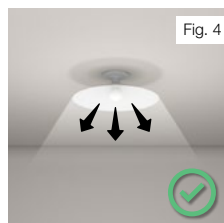
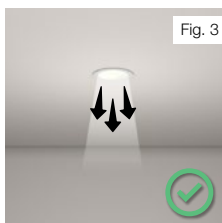
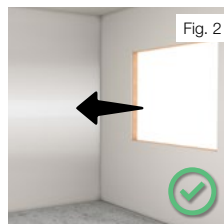
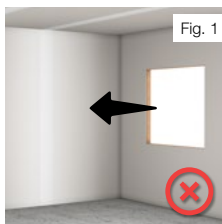

1.4.6 Other Factors that Influence the Finished Surface

- Heavily textured or patterned finishes tend to hide imperfections
- Smooth, monolithic painted surfaces tend to highlight imperfections
- Matt finishes will aid in disguising imperfections. Conversely, high gloss paint will accentuate imperfections
- Variations in surface, such as negative details, will remove the focus from imperfections
- The method of paint application has an effect. Paint applied by roller will aid in disguising imperfections. Paint applied by spray can accentuate imperfections
- Lighter colours are less likely to show imperfections and are more effective at diffusing light and reducing shadowing, particularly in smaller rooms

1.5 HEALTH AND SAFETY

Under normal conditions of use, GIB® plasterboard presents no known health hazard.

Construction sites can contain multiple hazards. It is important that appropriate health and safety requirements are strictly followed in such environments.

For further information on safety, handling and installing GIB® products and systems refer to the installation section.

1.6 COMPLIANCE

Under normal conditions of dry internal use GIB® plasterboard systems have a service life complying with the durability requirements of NZBC B2 Durability.

The systems and product testing referred to in this guide have been carried out and/or appraised by BRANZ and various other independent testing organisations.

1.7 LIMITATIONS

GIB® plasterboard:

- Must not be installed externally or exposed to weather elements for long periods of time without being covered or protected *(refer to exceptions below)
- Must not be handled or installed while in a very damp or wet state
- Must not be placed or installed directly into surface water
- Must not be exposed to chlorine rich environments or areas where relative humidity is greater than 90% RH for long periods of time like; group showers, steam rooms or indoor heated swimming pools
- Must not be exposed to temperatures greater than 52°C for long periods of time as this may cause calcination of the core. Carefully consider the heat output from fittings like: halogen lights, cooking elements, fire places and flues etc. Consult the fitting manufacturer for specifications
- Must not support ceiling loads that exceed an insulation weight of 4.2kg/m², and a fixture weight of 1kg or more unless they are independently supported. The placement of ceiling fixtures such as light fittings are to be limited to one fixture per m² unless independently supported
- Can develop mould growth if left wet or damp for extended periods of time and exposed to airborne or surface contaminants.

The plasterboard must be replaced if it has not been able to dry within approx. 48 hour period after becoming wet, or the water source has been contaminated

Electric Radiant Ceiling Heating (ERCH):

- ERCH systems may give rise to abnormal localised or overall temperature conditions in ceiling spaces which could affect the timber framing and GIB® plasterboard linings
- Excessive thermal or hygrometric movement induced by these systems may result in some, or combinations, of the following defects; deterioration of the gypsum in the GIB® plasterboard core (possibly affecting structural and fire resistant rating performance), fastener 'popping', joint peaking or joint cracking
- Prior to construction, we suggest you contact your designer to fully consider these factors in order to optimise surface finish quality
- Winstone Wallboards will not accept liability for surface finish quality problems where ERCH systems are installed in conjunction with any GIB® lining system

*Exceptions - the following range of plasterboard can be installed externally and exposed for the maximum times shown. The plasterboard must be installed in a dry state:

- 25mm GIB Barrierline® 12 weeks maximum
- 16mm GIB Fyrelite® (when used in the GIB Barrierline® system) 4 weeks maximum
- 10/13mm GIB Weatherline® 26 weeks maximum

1.8 COMPLAINTS PROCEDURE

Should a problem be encountered with any GIB® product during installation or delivery, immediately contact the GIB® Helpline on 0800 100 442. Do not continue to use the product that is not performing to specification or expectation.

Keep samples of the product in question and where possible, document batch numbers and/or manufacturing dates.

Because of the volume of information it is not feasible to include all the GIB® systems publications in the GIB® Site Guide.

If you are installing any of the following GIB® Systems it is important that you obtain a copy of the relevant publication.

These can be accessed by:

- Downloading from gib.co.nz
- Download the GIB® App available from the App or Google Play Stores
- Contacting the GIB® Helpline on 0800 100 442
- Or from most GIB® stockists

2.1 GIB® SYSTEM MANUALS



GIB EzyBrace® Systems

The GIB EzyBrace® Systems literature provides a guide to wall bracing of buildings constructed in accordance with NZS 3604:2011.

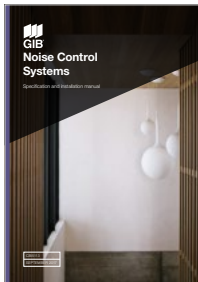

GIB Noise Control® Systems

GIB Noise Control® Systems provide the detail necessary to specify and install elements that will deliver noise control solutions for intertenancy and sub intertenancy requirements.



GIB Aqualine® Wet Area Systems

GIB Aqualine® with its water resistant core containing special polymers helps protect against damage to linings caused by moisture ingress.

The GIB Aqualine® Wet Area Systems literature provides full specification and installation details.

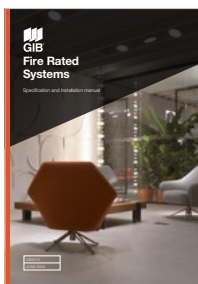

GIB® Fire Rated Systems

GIB® Fire Rated Systems literature has been compiled to make it easy to specify passive fire protection systems that will form part of a complete fire design.



GIB® Tough Systems

GIB® Tough Systems provides information on reducing the effects of impact damage to walls.

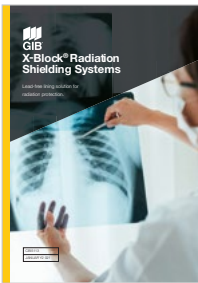

GIB X-Block® Radiation Shielding Systems

GIB X-Block® is a specialist plasterboard and jointing system to provide protection from X-ray radiation in medical facilities, dental clinics and veterinary practices.



GIB® Intertenancy Barrier Systems

Intended for multi-unit residential homes designed within the scope of NZS3604:2011, the GIB® Intertenancy Barrier System for Terrace Homes provides peace of mind, delivering fire, noise and security performance.

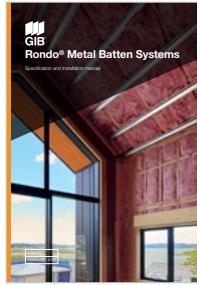

GIB® Rondo® Systems

GIB® Rondo® Metal Batten Systems are a simple way to ensure that you get a straight and true ceiling every time.

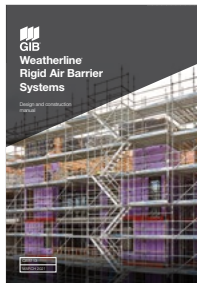

GIB Weatherline® Rigid Air Barrier Systems

GIB Weatherline® systems function as an air barrier and effective secondary line of defence against water penetration into the building interior.

Scan to view GIB® technical manuals



2.2 GIB® PLASTERBOARD RANGE

TE/TE – Both edges tapered. TE/SE – 1 tapered, 1 square edge, SE/SE – Both edges square.

Shaded box indicates availability

GIB® Standard

GIB® Standard is an economical lining material available in 10mm and 13mm thicknesses.

GIB Wideline® – 1350mm wide GIB® Standard is ideal for horizontal fixing for wall heights above 2.4m



	Thickness (mm)	Sheet Width (mm)	2400	2700	3000	3300	3600	4200	4800	6000	Max. kg/m ²
TE/TE	10	1200									7.0
TE/TE	13	1200									9.0
TE/SE	10	1200									7.0
GIB Wideline® TE/SE	10	1350									7.0
GIB Wideline® TE/SE	13	1350									9.0
GIB® Patch Board	10	1200 x 590									7.0

GIB Braceline® / GIB Noiseline®

GIB Braceline® / GIB Noiseline® is a dual purpose board that provides high level bracing performance when used in GIB® Bracing Systems and helps reduce noise transmission through walls and ceilings. Refer to GIB Noise Control® Systems literature for noise control installation requirements.



	Thickness (mm)	Sheet Width (mm)	2400	2700	3000	3300	3600	4200	4800	6000	Max. kg/m ²
TE/TE	10	1200									9.3
TE/TE	13	1200									12.5
TE/SE	10	1200									9.3
TE/SE	10	1350									9.3

GIB Aqualine®

GIB Aqualine® has a water resistant core to help prevent moisture penetration. Refer to the installation section or GIB Aqualine® Wet Area Systems literature for installation requirements.



	Thickness (mm)	Sheet Width (mm)	2400	2700	3000	3300	3600	4200	4800	6000	Max. kg/m ²
TE/TE	10	1200									8.0
TE/TE	13	1200									11.5
TE/SE	10	1200									8.0
TE/SE	13	1200									11.5
TE/SE	10	1350									8.0

GIB Ultraline®

GIB Ultraline® features a modified core for enhanced density and rigidity. Its Pearlcoat coated paper provides an enhanced surface appearance for high visibility areas.

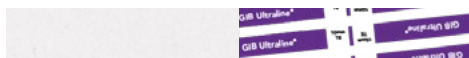

	Thickness (mm)	Sheet Width (mm)	2400	2700	3000	3300	3600	4200	4800	6000	Max. kg/m ²
TE/TE	10	1200									7.5
TE/TE	13	1200									9.4
TE/SE	10	1200									7.5

GIB Fyreline®

GIB Fyreline® has a high density modified core which resists exposure to fire longer than standard plasterboard. Refer to GIB® Fire Rated Systems literature for installation requirements.



	Thickness (mm)	Sheet Width (mm)	2400	2700	3000	3300	3600	4200	4800	6000	Max. kg/m ²
TE/TE	10	1200									7.5
TE/TE	13	1200									11.5
TE/TE	16	1200									15.3
TE/TE	19	1200									16.9

GIB Toughline®

GIB Toughline® is a high density, fibreglass mesh embedded plasterboard for added resistance to impact damage. Refer to GIB® Tough Systems literature for installation requirements.

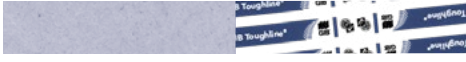

	Thickness (mm)	Sheet Width (mm)	2400	2700	3000	3300	3600	4200	4800	6000	Max. kg/m ²
TE/TE	13	1200									11.9

GIB Toughline® Aqua

GIB Toughline® Aqua is a multi-performance plasterboard with multiple attributes including noise attenuation, impact, water, fire and bracing resistance. See the appropriate system literature for installation requirements.



	Thickness (mm)	Sheet Width (mm)	2400	2700	3000	3300	3600	4200	4800	6000	Max. kg/m ²
TE/TE	13	1200									11.9

GIB Barrierline®

GIB Barrierline® plasterboard is a key component in the GIB® Intertenancy Barrier system. Refer to GIB® Intertenancy Barrier or GIB® Noise Control Systems literature for installation requirements.

	Thickness (mm)	Sheet Width (mm)	2400	2700	3000	3300	3600	4200	4800	6000	Max. kg/m ²
SE/SE	25	600									20.7

GIB Weatherline®

GIB Weatherline® sheets are a key component in GIB Weatherline® Rigid Air Barrier Systems. Refer to GIB Weatherline® systems literature for instruction requirements.

	Thickness (mm)	Sheet Width (mm)	2400	2450	2700	2750	3000	3300	3600	4200	Max. kg/m ²
SE/SE	10	1200									9.0
SE/SE	13	1200									11.5

GIB X-Block®

GIB X-Block® plasterboard provides protection from X-ray radiation. Refer to GIB X-Block® Systems literature for installation requirements.

	Thickness (mm)	Sheet Width (mm)	2400	2700	3000	3300	3600	4200	4800	6000	Max. kg/m ²
TE/TE	13	1200									18.3

GIB® Plasterboard Sheet Coverage

Sheet width	1200	1200	1200	1200	1200	1200	1200	1200	1200	1200	1350	1350	1350	1350
Sheet length	2400	2450	2700	2750	3000	3300	3600	4200	4800	6000	2400	3600	4800	6000
Sheet area m ²	2.88	2.94	3.24	3.30	3.60	3.96	4.32	5.04	5.76	7.20	3.24	4.86	6.48	8.10

Scan to view GIB® plasterboard range



2.3 GIB® PLASTERBOARD ALTERNATIVES

With the wide range of plasterboard types there are occasionally some overlaps in functionality. A tick ✓ indicates that the board can perform the same function as that of the original board.

For situations not covered below contact the GIB® Helpline on 0800 100 442.

		Proposed Alternative							
		GIB® Standard	GIB Fyreline®	GIB Braceline® GIB Noiseline®	GIB Aqualine®	GIB Ultraline®	GIB Toughline®	GIB Toughline® Aqua	GIB Weatherline®
Original 10mm Board		10mm	10mm	10mm	10mm	10mm	-	-	10mm
GIB® Standard	10mm		✓	✓	✓	✓			
GIB Fyreline®	10mm	✓ 13mm only		✓	✓	✓			
GIB Braceline®/ GIB Noiseline®	10mm		✓ 13mm or thicker only		✓ Notes 2 and 3				
GIB Aqualine®	10mm								✓
GIB Ultraline®	10mm								
Original 13mm Board		13mm	13mm	13mm	13mm	13mm	13mm	13mm	13mm
GIB® Standard	13mm		✓	✓	✓	✓	✓	✓	
GIB Fyreline®	13mm			✓	✓		✓	✓	
GIB Braceline®/ GIB Noiseline®	13mm		✓ Notes 1 and 3		✓ Notes 2 and 3		✓ Note 3	✓ Note 3	
GIB Aqualine®	13mm							✓	✓ Note 5
GIB Ultraline®	13mm								
GIB Toughline®	13mm							✓	

Note 1: Fastener type and length must be as specified for the relevant FRR system at 10mm centres to the perimeter of the element. The bracing element must be 900mm or greater. Corner fastening pattern applies.

Note 2: Fasteners at 100mm centres to the perimeter of the element. The bracing element must be 900mm or greater. Corner fastening pattern applies.

Note 3: The bracing function can be met but noise control will be reduced.

Note 4: If stopping and painting of GIB Weatherline® is anticipated refer to the GIB Weatherline® technical literature for more information.

Note 5: This alternative applies to wet area applications. 13mm GIB Weatherline® is not a direct substitute for 13mm GIB Fyreline® in fire-rated applications.

Weatherline has some cross-function capabilities but as it requires other components it may require a "system change". Check with the GIB® Helpline for more information.

2.4 GIB® FASTENERS



GIB® Grabber® Screws	Size	Qty/SKU	Qty/SKU	
Plasterboard to Timber – High Thread				
Loose	25mm x 6g	200 / 13950	1000 / 13955	
	32mm x 6g	200 / 13951	1000 / 13956	
	41mm x 6g	200 / 13952	1000 / 13957	
	51mm x 7g	100 / 14749	-	
	57mm x 7g	100 / 14743	-	
Collated	25mm x 6g	1000 / 13963	-	
	32mm x 6g	1000 / 13964	-	
	41mm x 6g	1000 / 13965	-	
	51mm x 7g	800 / 13966	-	
Plasterboard to Steel – Fine Thread, Self Tapping				
Loose	25mm x 6g	200 / 13941	1000 / 13947	
	32mm x 6g	200 / 13942	1000 / 13948	
	41mm x 6g	200 / 13943	1000 / 13949	
	51mm x 7g	100 / 14750	-	
	63mm x 8g	100 / 14744	-	
	76mm x 8g	100 / 14740	-	
Collated	25mm x 6g	1000 / 13960	-	
	32mm x 6g	1000 / 13961	-	
	41mm x 6g	1000 / 13962	-	
Plasterboard to Heavy Gauge Steel				
Collated	32mm x 8g	1000 / 15756	-	
	47mm x 8g	800 / 15757	-	
Plasterboard to Timber/Steel GIB® Grabber® Dual Thread				
Collated	32mm x 7g	1000 / 15491	-	
Metal to Timber – Wafer Head, Self Tapping				
Loose	32mm x 8g	200 / 14741	1000 / 14742	
Laminating Metal to Metal - Pancake Head Drill Tip				
Loose	13mm x 8g	500 / 15212	-	
Laminating Plasterboard to Plasterboard				
Loose	38mm x 10g	200 / 15758	-	

GIB® Fastenings coverage

Screws	Approx. 800 per 100m ² plasterboard
--------	--

Note: Refer to p.17 for the GIB Weatherline® screw range.

Scan to view
GIB® fastener
range



2.5 GIB BARRIERLINE® COMPONENTS

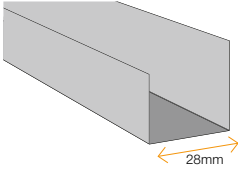
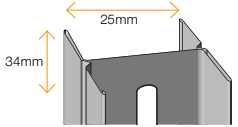
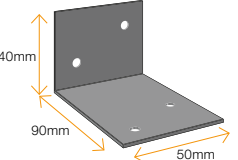
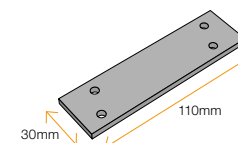

GIB Barrierline® Components					
Product	Use	Size (mm)	GIB® SKU	Suggested Qty per GIB Barrierline® Sheet	Image
GIB® Rondo® 140 Perimeter Channel	Supports GIB Barrierline® at sheet top and bottom and wall ends	3000	14936	0.5	
GIB® H-Stud	Supports GIB Barrierline® at vertical joints	3000	15618	1	
GIB® Wall Clip	Provides lateral support to the GIB® H-Studs	40 x 90 x 50	15619	2	
GIB® Wall Strap	Provides lateral support to the GIB® Rondo® 140 Perimeter Channel	110 x 30	15664	0.5	
Exterior Fire Acoustic Sealant	Sealant to one side of GIB® Rondo® 140 Perimeter Channel and floor slab		Suitable supplier	N/A	

Scan to view GIB Barrierline® information



2.6 GIB WEATHERLINE® COMPONENTS



GIB Weatherline® Components			
Tape	Size	GIB® SKU	Image
GIB® Flashing Tape	30mm x 30m	15776	
	60mm x 30m	15742	
	100mm x 30m	15743	
	150mm x 30m	15744	
	200mm x 30m	15745	
GIB® Sill Tape	150mm x 20m	15746	
	200mm x 20m	15747	

GIB Weatherline® Components					
Screw	Size	Qty	Framing Type	GIB® SKU	Image
Ceramic Coated High Thread Screw	41mm x 6g	Collated, 1000 per box	Timber	15741	
	63mm x 8g	Loose, 500 per box	Timber	15881	
Ceramic Coated Drill Point Screw	32mm x 8g	Collated, 1000 per box	Steel	15882	
	47mm x 8g	Collated, 800 per box	Steel	15881	

Scan to view GIB Weatherline® range





2.7 GIB® RONDO® METAL BATTEN CEILING SYSTEM

GIB® Rondo® Metal Batten Systems* provide a flat, stable ceiling substrate.

Vertical aligned components are compatible.

The long clips 313 and 394 will provide approx. 100mm additional drop below ceiling framing.

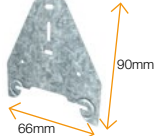
GIB® RONDO® 310	308 SYSTEM	129 SYSTEM
310 Batten SKU 12639 / 3.6m SKU 12640 / 4.8m SKU 12641 / 6.0m 	308 Batten SKU 14918 / 3.6m SKU 14919 / 4.8m SKU 14920 / 6.0m 	129 Batten SKU 14915 / 3.6m SKU 14916 / 4.8m SKU 14917 / 6.0m 
311D Clip SKU 12711 Adjustment range 2-30mm 	226 Clip SKU 14903 Adjustment range 2-30mm 	
313 Long Clip SKU 14907 Adjustment range 2-130mm 	394 Long Clip SKU 14909 Adjustment range 2-130mm 	
A311 GIB Quiet Clip® SKU 14209 Adjustment range 2-30mm Rubber Grommets 	STWC Acoustic Clip SKU 14984 Resilient mount. Direct fix to wall or ceiling. Accepts 129 or 308 batten. Also referred to as ST001. 	
312 Jointer SKU 12643 	138 Jointer SKU 14924 	
340 Perimeter Channel SKU 12642 / 3.0m 	142 Perimeter Channel SKU 14937 	140 Perimeter Channel SKU 14936 
NZ18 Perimeter Angle SKU 12645 / 3.0m Can also be used for internal corners in tiled shower situations. *NZ18 & GIBFix® angle compatible with all ceiling battens. 	GIBFix® Angle SKU 15662 / 2.4m SKU 15663 / 2.7m 	

*Note: GIB® Rondo® components are referred to elsewhere throughout this publication by product numbers rather than including the full GIB® Rondo® name e.g. GIB® Rondo® 310 Batten referred to as 310 batten.

SUSPENDED CEILING ACCESSORIES

547 Clip

SKU 14935

Fix vertically.
5mm galv. rod (121) is fitted by squeezing the two lugs of the 547 clip. Easily adjustable for height.



139 Clip

SKU 14925

Clicks into TCR at spacings to suit the ceiling lining, i.e. 450mm for 10mm plasterboard and 600mm for 13mm plasterboard.
Connects to 308 or 129 batten.



534 Clip

SKU 14934

5mm galv. rod (121) is fitted by squeezing the two lugs of the 534 clip. Easily adjustable for height.



BETAGRIP Clip

SKU 14914

For direct fixing to concrete walls or ceilings. Approx 25mm adjustment for height in 5mm increments.
Accepts 129 batten in all slots and 308 batten in upper 2 slots.
Previously known as BETAFIX CLIP.



121 Rod

SKU 14931 / 3.6m

5mm galv. rod for use with 547, 534, 2534, 8167 clips.



STSU Clip

SKU 14902

Ceiling resilient mount.
Fits into 127 or 128 TCR.
Accepts either 129 or 308 battens.



2534 Clip

SKU 14930

Friction fitted to 121 rod.
Connects to TCR 127 & 128.



167 Clip

SKU 14929

Side mount clip - low profile alternative for 2534 clip.
Connects 127 TCR to 5mm rod.
Provides height adjustment.
Only suitable for single layer systems.



127 TCR - 25mm

SKU 14921 / 3.6m
SKU 14922 / 4.8m

Top Cross Rail (TCR). Also called strongback, works with 2534 clip.



128 TCR - 38mm

SKU 14923 / 4.8m

Top Cross Rail (TCR). Also called a strongback. Works with 2534 clip.



A239 Clip - SKU 14911 / 100mm Rod

A239 Clip - SKU 14913 / 180mm Rod

237 Clip - SKU 14904 Clip only

For direct fixing to concrete walls or ceilings.
Accepts 129 or 308 Batten.



MISCELLANEOUS COMPONENTRY

BMCL Clip

SKU 15007

Provides plasterboard fixing to structural steel framing (max 10mm) in conjunction with 140 Perimeter channel.



GIB RAIL®

SKU 11164 / 3.0m

Fix directly to studs as per GIB® Noise Control system literature.

16mm (h) x 60mm (w)

Back of plasterboard will sit 13mm from framing.

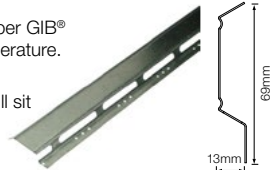

*Note: GIB® Rondo® components are referred to elsewhere throughout this publication by product numbers rather than including the full GIB® Rondo® name e.g. GIB® Rondo® 310 Batten referred to as 310 batten.

Scan to view GIB® Rondo® range





2.8 GIB® ADHESIVES AND SEALANTS

GIBFix® All-Bond

Solvent based adhesive suitable for most surfaces except polystyrene (Minimum application temperature is 5°C).



375ml Cartridge. SKU 13996
600ml Sausage. SKU 14478

GIBFix One®

Acrylic based adhesive with an ultra low VOC content. Compatible with timber/steel framing (Minimum application temperature is 10°C).



375ml Cartridge. SKU 15037
600ml Sausage. SKU 15041
4 litre Pail. SKU 15038

GIB Fire Soundseal®

Multi use acoustic sealant that resists the passage of smoke and fire.



375ml Cartridge. SKU 15759
600ml Sausage. SKU 15760

GIB® Gapfiller

Multipurpose acrylic gapfiller with an ultra low VOC content. Paintable



300ml Cartridge. SKU 15039

GIB® Adhesive Coverage

375ml cartridge	17m ² plasterboard
600ml sausage	28m ² plasterboard
4 litre pail	170m ² plasterboard

GIB Fire Soundseal® Coverage

Bead Size	375ml Cartridge	600ml Sausage
10mm x 10mm	3.75 lineal metres	6.0 lineal metres
10mm x 5mm	7.5 lineal metres	12.0 lineal metres

2.9 GIB-COVE®

All profiles available in 3.6m lengths.

Mezzo/SKU 15686

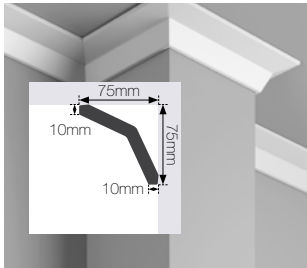

Tenor/SKU 15688

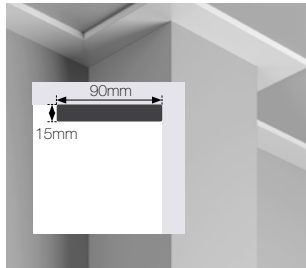

Basso/SKU 15687

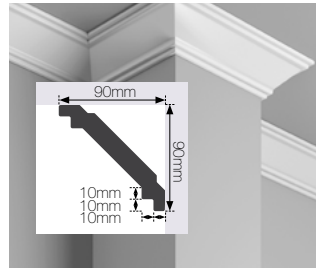

Alto/SKU14485

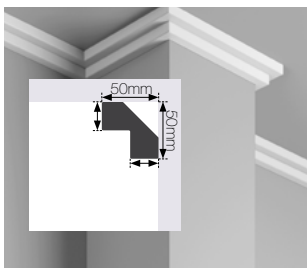

Classic 90mm/SKU 11333, 75mm/SKU 13701, 55mm /SKU 12314

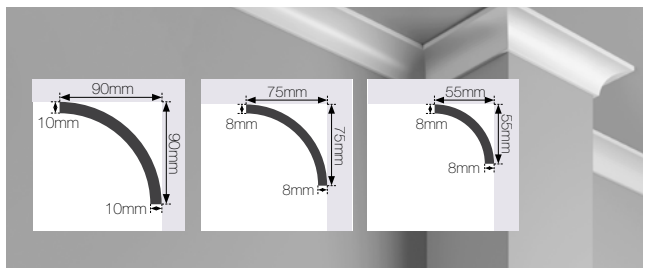

2.10 GIB® COMPOUNDS

Compounds fall into two general categories, setting compounds and air drying compounds.

Air Drying Compounds

- Ready to use materials
- Easy to sand producing a smooth finish
- Harden as they dry. Drying can be slow if applied thick and in poor drying conditions

Setting Compounds

- Harden and set by chemical reaction with water
- Supplied in powder form and mixed with clean water to the correct consistency
- The working time is controlled during manufacture so that compound sets and goes hard after a specified time
- Must not be mixed with other compounds
- Must not be applied over air drying materials

Setting Compounds

GIB Tradeset®



- Ideal for bedding tape
- Machine tool compatible
- Variety of working times available

Product Size	5kg*, 20kg Bag	Base Coat	✓
Working/Set Times (mins)	20, 45, 90 & 150**	Second Coat	✓
		Finishing Coat	✗
		Suitable for GIB-Cove®	✗
		Compound Type	Setting
		Scraping	Easy

GIB MaxSet®



- Mechanically strong
- Strong tape adhesion
- Sets hard for faster jointing
- Maximum coverage with low shrinkage

Product Size	20kg Bag	Base Coat	✓
Working/Set Times (mins)	90	Second Coat	✓
		Finishing Coat	✗
		Suitable for GIB-Cove®	✗
		Compound Type	Setting
		Scraping	Only while 'green'

GIB Lite Blue®



- Easy to sand
- Machine and hand tool application
- Low shrinkage

Product Size	17.5kg Bag	Base Coat	✗
Working/Set Times (mins)	90	Second Coat	✓
		Finishing Coat	✗
		Suitable for GIB-Cove®	✗
		Compound Type	Setting
		Sanding	Easy

GIB LiteSet®



- Very easy to sand

Product Size	18kg Bag	Base Coat	✓
Working/Set Times (mins)	90	Second Coat	✓
		Finishing Coat	✗
		Suitable for GIB-Cove®	✗
		Compound Type	Setting
		Sanding	Very easy

*5kg only available in 45min set time

**GIB Tradeset® 150 is only available in 20kg bags

Air Drying Compounds

GIB Trade Finish® Heavy Weight



- Heavy weight, suitable for machine sanding
- Cool weather application
- Super slick to trowel or apply with box
- Full body trowelling
- Ideal for filling or covering uneven surfaces

		Base Coat	✗
		Second Coat	✗
		Finishing Coat	✓
		Suitable for GIB-Cove®	✗
Product Size	15L Pail	Compound Type	Air Drying Ready Mix
Working/Set Times (mins)	-	Sanding	Hard

GIB Trade Finish® Multi



- Medium weight multi purpose
- Super slick to trowel or apply with box
- Yellow tint enables easy identification

		Base Coat	✓
		Second Coat	✓
		Finishing Coat	✓
		Suitable for GIB-Cove®	✗
Product Size	10L, 15L Pail & 14L Carton	Compound Type	Air Drying Ready Mix
Working/Set Times (mins)	-	Sanding	Moderate

GIB Trade Finish® Lite



- Easy sanding light weight compound
- Super slick to trowel or apply with box
- Yellow tint enables easy top coat identification

		Base Coat	✓
		Second Coat	✓
		Finishing Coat	✓
		Suitable for GIB-Cove®	✗
Product Size	15L Pail & 14L Carton	Compound Type	Air Drying Ready Mix
Working/Set Times (mins)	-	Sanding	Easy

GIB Trade Finish® Extra Lite



- Very easy sanding light weight compound
- Super slick to trowel or apply with box
- Yellow tint enables easy top coat identification
- Warm weather application

		Base Coat	✓
		Second Coat	✓
		Finishing Coat	✓
		Suitable for GIB-Cove®	✗
Product Size	15L Pail & 14L Carton	Compound Type	Air Drying Ready Mix
Working/Set Times (mins)	-	Sanding	Very Easy

GIB Plus 4®



- Suitable for all three jointing coats
- Ideal for skim coating
- Excellent adhesion to a variety of substrates

		Base Coat	✓
		Second Coat	✓
		Finishing Coat	✓
		Suitable for GIB-Cove®	✗
Product Size	4L, 10L & 15L Pails	Compound Type	Air Drying Ready Mix
Working/Set Times (mins)	-	Sanding	Easy

Note: For guidance on approximate drying times for air drying compounds refer to p.90.

Scan to view GIB® compound range



Repair Compounds

GIB® RediFilla™



- Repair scratches, dents, nail heads and cracks
- Sandable, paintable, low shrinkage, good adhesion
- Ready to use

Product Size	2L & 4L Pails
Working/Set Times (mins)	-

Base Coat	✓
Second Coat	✓
Finishing Coat	✓
Suitable for GIB-Cove®	✗
Compound Type	Air Drying Ready Mix
Sanding	Easy

GIB® TradeFilla™



- Quickly repair and fill holes
- Paintable and doesn't need a finishing coat
- Can apply second coat after 30 minutes if required

Product Size	5kg Bag
Working/Set Times (mins)	10

Base Coat	✓
Second Coat	✓
Finishing Coat	✓
Suitable for GIB-Cove®	✗
Compound Type	Setting
Sanding & Scraping	Moderate

Cove Bond

GIB-Cove® Bond



- Excellent "wet tack"
- Required for back blocking
- Two setting times available

Product Size	5kg* & 20kg Bags
Working/Set Times (mins)	45 & 90

Base Coat	✗
Second Coat	✗
Finishing Coat	✗
Suitable for GIB-Cove®	✓
Compound Type	Setting
Scraping	Hard

Victor® Cornice Bond



- Specifically designed for adhering fibrous plaster products

Product Size	20kg Bag
Working/Set Times (mins)	30

Base Coat	✗
Second Coat	✗
Finishing Coat	✗
Suitable for GIB-Cove® / Fibrous Mouldings	✓
Compound Type	Setting
Scraping	Hard

Specialty Compounds

GIB X-Block® Jointing Compound



- Eliminates the need for backing joints with lead strip
- High strength joint when used in conjunction with paper joint tape
- Can be finished with any of the GIB® finishing compounds

Product Size	25kg Bag
Working/Set Times (mins)	90

Base Coat	✓
Second Coat	✗
Finishing Coat	✗
Suitable for GIB-Cove®	✗
Compound Type	Setting
Sanding	Polished / Not Sanded

2.11 CHANGE COMPOUNDS FOR DIFFERENT SEASONS

Drying conditions change and compounds become harder or softer to sand.

The GIB Trade Finish® range ensures a product is available that has similar trowelling properties through the range, but different sanding characteristics to suit different seasons or drying conditions.

The warmer the weather, the harder the product will become to sand.

The colder the weather, the softer the same product will become to sand.

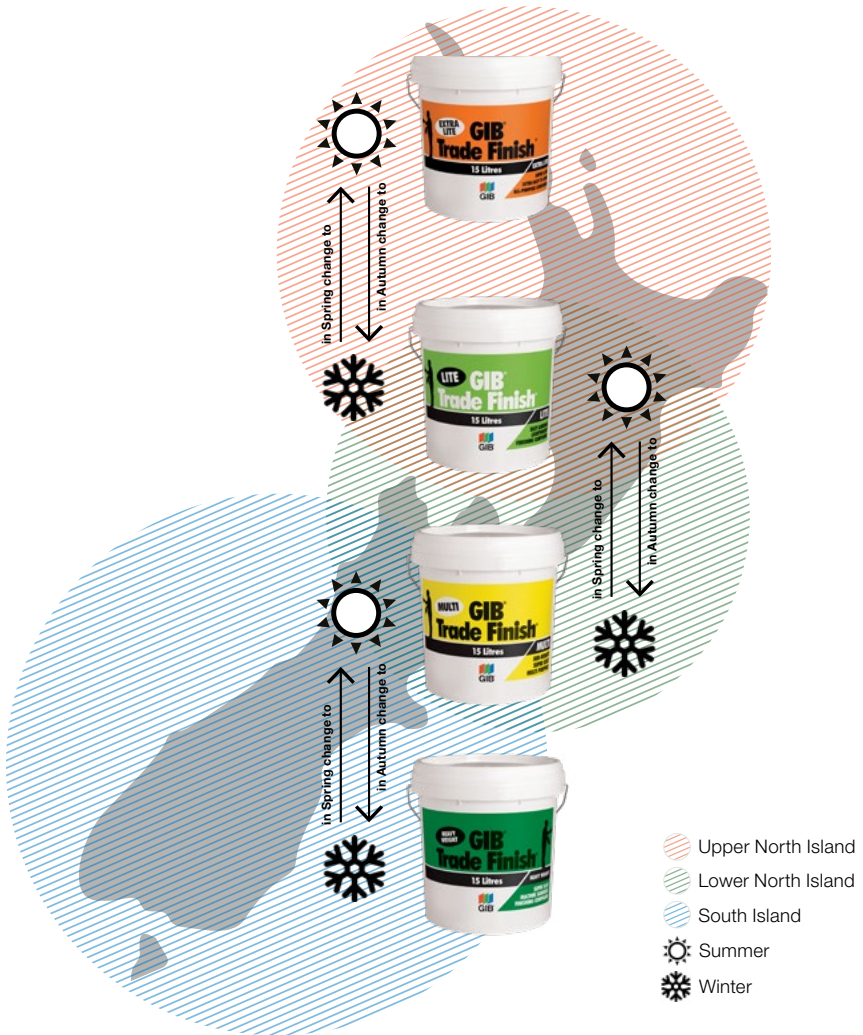

2.12 GIB® PAPER FACED TRIMS

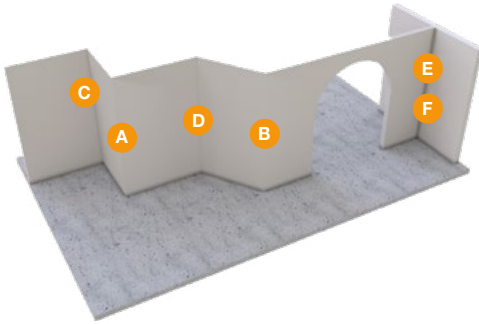

GIB® Goldline® Trims are made with a patented, high quality paper laminated to galvanised steel forms. The metal provides maximum strength and protection for the corner, while the paper face matches the plasterboard paper surface to help create a more uniform surface finish.

GIB® Goldline® Trims do not require mechanical fixing.

Ext 90° GIB® Goldline® Corner Trim G1-W

SKU 12589 / 2.4m
SKU 12590 / 2.7m
SKU 12591 / 3.0m

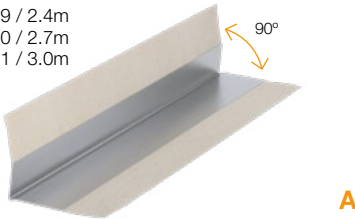

GIB® Goldline® Bullnose Ext 90° Corner Trim G1-B

SKU 12584 / 2.4m
SKU 12586 / 3.0m

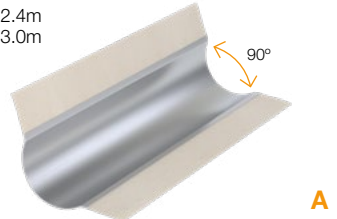

Ext 135° GIB® Goldline® Corner Trim G1-O

SKU 12599 / 2.4m

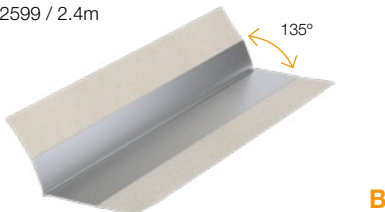

Int 90° GIB® Goldline® Corner Trim G2 Standard

SKU 12594 / 2.4m
SKU 12595 / 2.7m
SKU 12596 / 3.0m



Int 135° GIB® Goldline® Corner Trim G2-O

SKU 12592 / 2.4m

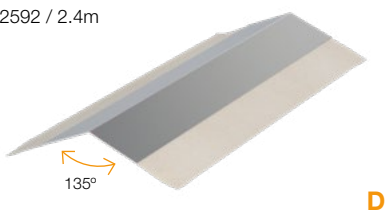

GIB® Goldline® Reveal GR

SKU 12602 / for 10mm GIB® plasterboard 3.0m
SKU 12601 / for 13mm GIB® plasterboard 3.0m



GIB® Goldline® L-Trim G4

SKU 12604 / for 10mm GIB® plasterboard 3.0m
SKU 12598 / for 13mm GIB® plasterboard 3.0m

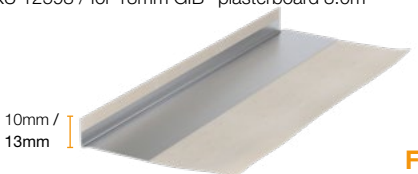

2.13 GIB® METAL TRIMS

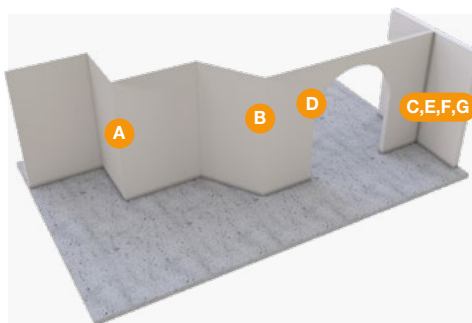

GIB® Metal Trims provide a clean defined edge on either straight or curved details. The perforated legs provide a strong key for compounds and the sharply defined nib provides a knock resistant corner.

GIB® Metal Trims are to be mechanically fixed.

Ext 90° GIB® Slim Angle

P01

External 90 degree perforated corner trim

2.4m / SKU 12562
2.7m / SKU 12563
3.0m / SKU 12564

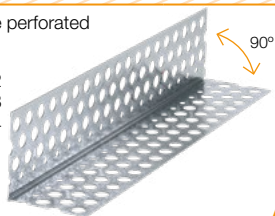

A

Ext 135° GIB® Slim Angle

P01A

External 135 degree perforated corner trim

2.4m / SKU 12566
2.7m / SKU 14972
3.0m / SKU 14973

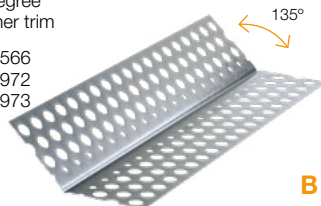

B

Rondo® Stopping Angles

P25/26/27

L-Trim for stopped end trim

P25 10mm x 3m / SKU 14941
P26 13mm x 3m / SKU 14942
P27 16mm X 3m / SKU 14943

10mm / 13mm / 16mm

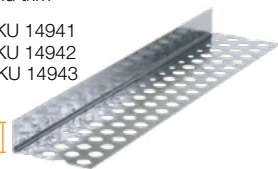

C

GIB® Slim Arch Bead

P10

Perforated curvable corner edge trim

2.4m / SKU 12565
3.0m / SKU 14945



D

Rondo® Stopping Beads

P12/13

End cap bead – stopped

P12 10mm x 2.4m / SKU 14955
3.0m / SKU 14957
P13 13mm x 2.4m / SKU 14958
3.0m / SKU 14960

10mm / 13mm

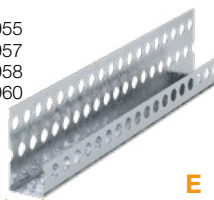

E

Rondo® Shadowline Stopping Bead

P50

Reveal or Z-trim

P50 3.0m / 14962

10mm



F

Rondo® Casing Bead

P05/7

End cap bead – unstopped

P05 10mm x 2.4m / SKU 14947
P07 13mm x 3.0m / SKU 14952

10mm / 13mm



G

Scan to view GIB® trims range



2.14 CONTROL JOINTS



GIB® Plastic W-Profile Control Joint

White plastic W-profile control joint provides for a discrete finish and has tear-away tabs for easy installation. This trim is thicker than the other control joint trims and thus may have implications for the final joint height.

3.0m / SKU 15629



GIB® Goldline® Trims to Create a Control Joint

A combination of a GIB® Goldline® Reveal trim and an L-Trim used to create a control joint. The GIB® Goldline® trims have a paper finish (matching the plasterboard paper) and once installed are ready for painting.

Available in 3.0m lengths.

- Reveal trim for 10mm GIB® plasterboard/ SKU 12602
- Reveal trim for 13mm GIB® plasterboard/ SKU 12601
- L-Trim for 10mm GIB® plasterboard/ SKU 12604
- L-Trim for 13mm GIB® plasterboard/ SKU 12598

Where possible (clearances allow) use a 13mm Reveal trim in combination with a 10mm L-Trim.

GIB® Goldline® L-Trim



GIB® Goldline® Reveal Trim

GIB® Rondo® Metal P35 Control Joint

Metal control joint providing excellent relief for structural movement and is easily installed.

3.0m / SKU 14964



2.15 GIB® ADDITIONAL COMPONENTS

GIB® Paper Joint Tape

A critical element to reinforce joints. Spark perforated to aid drying and adhesion. Buffed underside to aid bonding with compound.

75m x 52mm / SKU12475
150m x 52mm / SKU 12474



GIB RocTape®

Similar to GIB® Paper Joint Tape and can be installed using hand tools or mechanical tools. Suitable for flat joints only.

75m x 50mm / SKU 15634



GIB® UltraFlex® No Coat

High Impact Flexible Composite Trim suitable for all off angles interior or exterior.

30m x 325" (82mm) / SKU 14986
30m x 450" (112mm) / SKU 14543



GIB® Levelline™ Trim

A foldable composite trim with a paper face to match the paper face of GIB® plasterboard for a more uniform finish on corners.

30m x 70mm / SKU 15314



GIB HandiBrac®

Required in specific bracing elements.

Sold in pairs complete with Tek screws and screw-bolt. Must be installed as per GIB EzyBrace® Systems literature.

Box 20 / SKU 15943



3.0 SUSTAINABILITY



GIB® plasterboard is a sustainable, non-toxic, compostable product made from natural gypsum and 100% recycled paper.

3.1 WASTE MINIMISATION

Ever increasing pressure is being placed on waste disposal facilities. As the construction industry is a major contributor of waste material, consideration should be given to methods of waste minimisation.

The use of longer sheets and horizontal fixing helps reduce on-site waste. GIB® plasterboard off cuts,

if separated from other waste building materials, can be readily recycled. For larger projects the waste can be diverted to compost manufacturers who grind up the GIB® plasterboard and utilise it in compost.

3.2 PLASTERBOARD OFFCUT RECYCLING SERVICES

GIB® plasterboard can be recycled with the gypsum core reused in a range of compost and agricultural products. This allows customers the opportunity to divert plasterboard offcut away from landfill.

A list of recycling businesses offering plasterboard offcut site collection and recycling services as well as more information on GIB® plasterboard sustainability initiatives can be found at gib.co.nz/sustainability

4.0 PRE – INSTALLATION

Achieving a satisfactory finished wall or ceiling surface is the result of teamwork involving several trades and disciplines.

There is no place in the industry for the phrase “The stopper will fix it”.

All trades involved in the process have to take full responsibility for the quality of their workmanship.



Designers

- Convert the client’s brief into working drawings
- Comply with Building Code requirements and ensure that all relevant standards are applied
- Determine final decoration
- Determine lighting design to achieve functional requirements and optimised quality of finish
- Determine the level of finish required
- Determine the location of control joints
- Provide sufficient detail on the drawings for trades people to interpret accurately



Plasterboard Installers

- Check the substrate prior to installing plasterboard
- Ensure that remedial work is carried out before any plasterboard is installed
- Check with builder that the pre-lining inspection has taken place and the timber moisture content does not exceed 18%
- Install plasterboard to manufacturer’s instructions
- Provide an acceptable substrate for the plasterboard stopper



Builders

- Provide project management and supervision to ensure that the site is ready for each incoming trade
- Co-ordinate the sub-trades
- Site management to provide suitable dry storage for plasterboard products



Stoppers

- Check the substrate prior to commencing finishing work
- Ensure that remedial work is carried out before finishing
- Carry out stopping work in accordance with manufacturer’s instructions and the requirements of AS/NZS 2589:2017
- Provide an acceptable substrate for the painter



Carpenters

- Ensure framing is erected plumb, straight, level and flat
- Ensure that ceiling battens are all running in the same direction within rooms
- Provide an acceptable substrate for the plasterboard installer

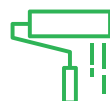

Painters

- Check the substrate prior to painting
- Ensure that remedial work is carried out before any painting commences
- Apply paint according to the manufacturer’s instructions and to best trade practice

4.1 DELIVERY OPTIONS

GIB® products are supplied in three delivery options:

- Freight into Merchant Stores (FIS): Available nationwide
- Delivered to Site (DTS) : Available in Auckland, Hamilton, Tauranga, Wellington and Christchurch
- Ex-Warehouse Collection: Available in Wellington and Christchurch

4.1.1 DTS Standard Delivery Options

Standard truck

Includes a driver and one labourer only:

- The plasterboard is delivered to the nearest point of cover within 20 metres (i.e. the garage or closest open area)
- If plasterboard needs to be split into two or more areas, carried more than 20 metres, upstairs or the foundation height is over 400mm, then Specialised Delivery services will be required with extra labour charges

Standard hiab

Includes the driver only:

- The standard hiab reach is up to 15 metres

Standard hiab

Includes the driver only up to 2 hours.

STANDARD DELIVERY EXAMPLE



4.1.2 Specialised Delivery Options - Additional Charges Over Standard Deliveries

Extra labour

- Extra labour is available for plasterboard that needs to be split into two or more areas, carried more than 20 metres, upstairs or when foundation height is over 400mm
- Two extra labourers are required per level or per 20 metres or part thereof
- A minimum labour charge of 3 hours per two people applies from Winstone Wallboards depot and back to the Winstone Wallboards depot, thereafter an hourly rate applies

EXTRA CHARGES EXAMPLE

20 metres extra (2 extra labourers) + one flight of stairs/level (2 extra labourers) + 20 metres extra (2 extra labourers) = 6 extra labourers



HIAB/CRANE CHARGES EXAMPLE

15 metres extra (2 extra labourers)



4.2 IS YOUR SITE PLASTERBOARD READY

Plasterboard ready

- Good access to the site
- Excellent housekeeping
- Clear internal access



Not plasterboard ready

- No clear access to site (e.g. skip or building material blocking access)
- Obstructing the building access (e.g. scaffolding, ladders, saw horses, temporary balustrades or barricades blocking access)
- Poor housekeeping that may increase risk of injury (e.g. uneven ground, waste, tools or building materials blocking clear paths)
- No clear access for flat placement of plasterboard (e.g. waste, building materials or tools cluttering available floor space)



4.3 SITE CONDITIONS

It is important to consider the impact of damp and cold site conditions during the construction process on the finish quality once the building has been occupied and reaches equilibrium.

Maintain a minimum temperature (interior) of 10°C during the plasterboard fixing process and a controlled temperature of above 10°C for 24 hours before, during and after the joint stopping

process. With concrete slab construction, provide sufficient ventilation to minimise the build-up of internal humidity (which increase the risk of sagging of plasterboard as well as delaying the project due to prolonged drying/curing of joint compounds).

Failure to observe these requirements may result in framing and plasterboard surface defects.

4.4 STACKING, STORAGE AND HANDLING

GIB® plasterboard is a finishing product and needs to be handled as such. For safety reasons, plasterboard sheets should be stacked horizontally wherever possible, taking the following considerations into account:

- To avoid sheet distortion or damage, sheets must be neatly stacked on a clean surface not susceptible to moisture
- Sheets stacked flat on a concrete floor must be separated from the floor surface by a moisture barrier (e.g. polythene sheet)
- Consider floor loadings as GIB® plasterboard weighs in the range of 700–800kg/m³
- Stacks should be limited to 300mm high on suspended floors to minimise the risk of structural damage through point loading

Due to the complexity of a construction site and the restricted site conditions, it is not always possible to horizontally stack plasterboard on a flat surface. Plasterboard can be stored vertically against timber framing as a last option, taking the following considerations into account:

- For safety reasons and to prevent sheets from falling, vertical supports/restraints must always be used when plasterboard is vertically stacked
- The maximum number of 10mm and 13mm sheets that can be vertically stacked is 20 against timber framing. This reduces to 13 sheets maximum for 16mm and 19mm GIB Fyreline®
- To reduce the risk of toppling, the first sheet must be placed 150–180mm from the bottom plate
- Winstone Wallboards does not recommend stacking sheets vertically on the short edge

Plasterboard must not be vertically stored where steel framing is used. When handling plasterboard sheets, lift sheets from the stack rather than dragging them. This also reduces the risk of face paper damage. Carry sheets on edge. This is easier than carrying them on the flat and sheets are less likely to crack or break.

Horizontal Storage

300mm max. on suspended floors



Vertical Storage

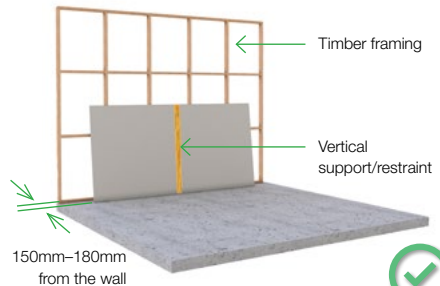

Applicable to all flooring types



4.5 PROTECTION FROM WEATHER

Other than installing GIB Weatherline® and GIB Barrierline® systems do not install GIB® plasterboard in any situation where external claddings, or NZ Building code approval rigid/flexible air barrier systems are not in place or which is not totally protected from the elements. If plasterboard is installed under such conditions it

greatly increases the risk of surface defects such as cracked or peaked joints and fastener pops.

GIB® plasterboard must be kept dry preferably by being stored inside a building and under cover. Where it is necessary to store GIB® plasterboard outside, it must be stacked off the ground and be fully protected from the weather.

4.6 ORDERING AND DELIVERY

At the time of ordering, consider specifying which sheet sizes are designated for walls and those for ceilings so that they can be placed in separate stacks.

With the extensive GIB® product range it is impossible for building merchants to stock all types and sizes of product. Planning ahead will mean you can get the exact products you require.

Deliver GIB® plasterboard to site immediately prior to installation to reduce the risk of damage.

4.7 TIMBER MOISTURE CONTENT

The moisture content of timber at the time of fixing plasterboard must be 18% or less.

Fixing plasterboard to timber with moisture content exceeding 18% will increase the risk of surface defects such as peaked or cracked joints and popped fasteners.

Winstone Wallboards strongly recommends builders invest in the use of moisture meters to check timber framing is suitable for plasterboard linings prior to installation.

Winstone Wallboards recommends a lower moisture content (8% to 18%) if air conditioning, heat pumps or central heating are to be installed.

The objective should be to install linings to timber framing with a moisture content as close as possible to the final equilibrium level of the complete and occupied building.

Winstone Wallboards recommends:

- The use of GIB® Rondo® metal ceiling battens
- The use of Kiln Dried Machine Stress Graded (KDMG) timber for all wall, roof and mid-floor framing members

Note: Mixing KDMG framing with non KD timber can cause undue substrate movement and is not recommended.

4.8 SITE HEALTH AND SAFETY

Construction sites can contain multiple hazards. It is important that appropriate health and safety requirements are strictly followed at all times.

Before commencing any installation work, familiarise yourself with the safety requirements of the site you are working on.

Identify any potential hazards, applying the steps in the table to the right.

Under normal conditions of use, GIB® plasterboard presents no known health hazards.

1. **Eliminate the Hazard** - Eliminate the hazard altogether if at all possible
2. **Isolate the Hazard** - Install barriers or guard rails to isolate people from the hazard
3. **Minimise the Risk of Harm** - For example, use fall restraints or provide soft landing systems to minimise the risk of harm

4.9 REQUIRED TOOLS

Plasterboard installation requires a range of general carpentry tools

- Hammer
- Folding rule
- Hand rasp - Surform
- Straight edge
- Keyhole saw
- Flat Lifting bar
- Adhesive gun
- Measuring tape
- Plasterboard knife
- T square
- Nail punch
- Plasterboard saw
- Drywall screwdriver

5.0 GENERAL WALL AND CEILING INSTALLATION

This section covers the installation of GIB® plasterboard in walls and ceilings. Installation guidance is also provided for speciality systems; GIB EzyBrace® and GIB Aqualine® Wet Area Systems.

For further installation guidance including system specifications for other speciality GIB® systems refer to the appropriate system literature at gib.co.nz

5.1 BEFORE STARTING INSTALLATION

Inspect the framing

Check that the surface is flat and that there is nothing that could affect the finished surface. For example:

Nogs not flush.



Nails not below the framing surface.



Do not simply rely on the building inspector at the pre-line inspection but take responsibility and understand the effects of framing moisture on content and the quality of finish.

Moisture content to be 18% or less.

Moisture loss in timber framing can lead to screw pops and/or joint cracks.



Nail plates or hold down ties not checked in flush with the surface insulation bulging out between studs.



These are all factors that will affect the quality of the finished surface. **The time to correct them is now.** Once fixing commences it indicates an acceptance of the substrate quality.

It is the responsibility of the framing contractor to provide a substrate that allows the plasterboard fixer to effectively install the plasterboard in accordance with the manufacturer's instructions.

Likewise it is the responsibility of the plasterboard fixer to provide a suitable surface for the plasterboard stopper to effectively carry out the stopping process.

There is no place in the industry for the phrase "The stopper will fix it".

All trades involved in the process have to take full responsibility for the quality of their workmanship.

Tip: For easier installation it is recommended to install the plasterboard ceiling before lining the walls.

Cutting GIB® Plasterboard

Measure the wall to determine the required sheet size. Generally cut the sheet 2mm–3mm less than the exact dimension needed.

Position the sheet with the face paper side up. Mark the sheet as required.

Firmly hold the straight edge on the line to be cut.

Cut through the face paper and into the plaster core by sliding the knife blade against the straight edge.

Break the sheet core by snapping the sheet back firmly while holding on to the sheet edge.

Turn the sheet over so that back paper is now facing up. Score the back paper to complete the cut.



Scan to view GIB® installation videos



Cutting GIB® Plasterboard

For sheets requiring multiple cuts, use a handsaw to complete the short cuts before scoring and snapping the longer cut.

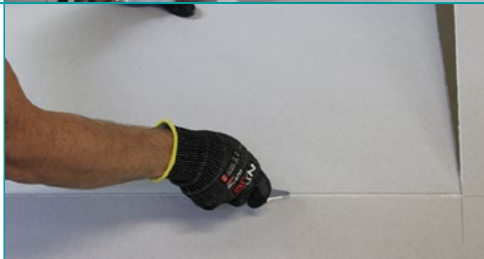
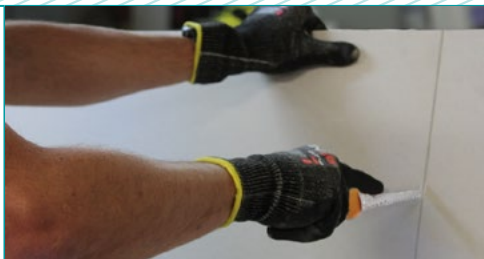

Mark the position of any power outlets or pipes on the face of the board.

Make hole at a corner of the marked outlet. Cut out the box as marked.

Tip: To get the saw started, drill holes at each of the corners but within the opening. In some cases the saw can simply be pushed through the sheet without the need for holes.



Fixing GIB® Plasterboard

Apply GIBFix® adhesive at specified centres. Apply immediately prior to fixing the GIB® plasterboard. Do not allow time for the adhesive to “skin” over.

GIBFix® adhesive daubs should be approximately 35mm in diameter and about 12mm high.

Cold temperatures (10°C or less) will affect the curing time of adhesive. It is recommended that steps are taken to achieve 10°C at the time of installation.

Tip: Do not place GIBFix® adhesive behind fasteners. This will increase the risk of “fastener popping”. Place at least 200mm from fasteners

Fit the GIB® plasterboard in position against the framing. Press the sheet firmly against the framing to ensure a good bond with the adhesive.

Sheets must be 5–10mm from the floor. Place packers to suit OR use a flat bar to lift the sheet off the floor.

(Note that some specific fire rated systems require that the sheets are fixed hard to the floor).

Install fasteners at specified centres. Make sure that the head of the fastener is bedded just below the surface of the board.

Tip: Use an electric drywall screw gun equipped with an adjustable depth control head and Phillips bit. If a screw is overdriven and the paper and/or core of the GIB® plasterboard is damaged, insert a second screw approximately 50mm from the first and then remove the first screw.



Temporary Fixing

Temporary direct fix screws through blocks

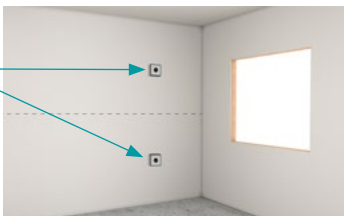

Tip: Occasionally a bow may develop in the board due to storage methods. It might be necessary to temporarily hold the board until the adhesive cures.

Screw through an offset of plasterboard and remove the block and screw once adhesive has cured.

Joint Placement

Give careful consideration to the placement of sheet joints in walls and ceilings.

Try to minimise sheet joints by using the largest sheet size available.

Where possible place joints in situations where they are less likely to be affected by critical lighting.

Horizontal Fixing

Sheet edge joints in horizontally fixed walls may be unsupported (stud centres must not exceed 600mm).

For levels of finish 3 and 4, sheet end butt joints may be made on studs. However, to reduce the risk of joint defects, it is strongly recommended that sheet end butt joints are back blocked off framing.

Vertical Fixing

Form sheet edge joints in vertically fixed walls on studs.

Shorter vertical joints (400mm or less) such as above a window or door can be made off the stud. Joints under windows can be made off the stud provided that nogs are installed to reduce the unsupported joint to 600mm or less. Alternatively the joint may be back blocked.

Around Door or Window Openings

Sheet edge joints formed at the edge of door and window openings are highly prone to cracking. To reduce the risk of cracking it is strongly recommended that sheets are cut around openings and joints are formed no closer than 200mm to the edge of the opening.

General Installation – Not recommended

Prone to cracking due to frame flexibility. Not recommended for general installations.

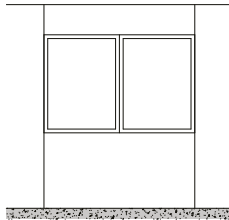

General Installation – Not recommended

Time consuming for no real benefit. Still highly prone to cracking.

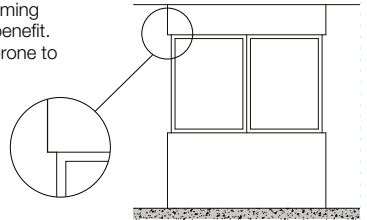

General Installation – Acceptable

This moves the joint away from problem area. Floating joint, correctly taped and stopped is less likely to crack.

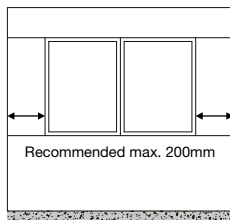

General Installation – Acceptable

Positioning the joint 200mm from the window edge will reduce the likelihood of cracking.

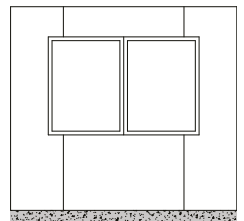

General Installation – Recommended

If the grooved jambs have been accurately installed, this is not difficult for a competent fixer. The lining on this wall will need to be fixed prior to any adjacent walls.

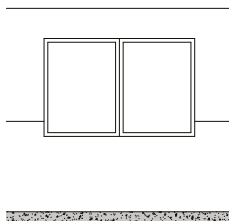

High Movement Applications

For applications prone to a high degree of movement, such as transportable homes, consideration should be given to installing a control joint at the edges of the door or window. (see p.52)

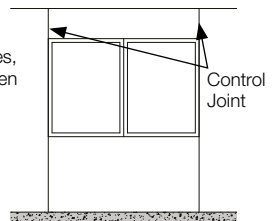

5.3 GIB® PLASTERBOARD INSTALLATION – WALLS

For installation guidance on GIB EzyBrace® and GIB Aqualine® Wet Area Systems refer to the GIB® Performance Systems section.

For all other GIB® Performance Systems refer to the relevant GIB® Systems literature.

5.3.1 Timber Frame – Horizontally Fixed

Wall Framing

- Framing dimensions, spacings and nog requirements must comply with NZS3604:2011
- Timber moisture content must not exceed 18% (see p.34)
- If required nogs to be evenly spaced with a maximum spacing of 1350mm. If staggering nogs off a centreline it is recommended a maximum offset of 50mm–75mm
- Nogs are not required behind the horizontal joint except in shower situations and specific fire, noise or impact prone area, such as stairwells or doorways

Fasteners

- 10mm GIB® plasterboard, minimum 25mm x 6g GIB® Grabber® high thread screws*
- 13mm GIB® plasterboard, minimum 32mm x 6g GIB® Grabber® high thread screws*

Installation

- 300mm max to top and bottom plates and perimeter studs

- Pairs of single fasteners to each stud where horizontal joint crosses
- Place fasteners no closer than 12mm from paper bound sheet edge or 18mm from any cut edge
- Fasteners at wall corners to be placed 50mm max in from the corner in each direction
- Do not place GIBFix® adhesive at sheet edges or within 200mm of fasteners
- Place daubs of GIBFix® adhesive 300mm max centres to intermediate studs
- Sheet edges at door or window openings can be adhesive fixed unless forming part of the perimeter of a bracing element
- Butt joints to be on framing or back-blocked
- Fasteners to be positioned no closer than 25mm from each other

Stopping

- Refer to the Jointing and Finishing section (p.86)

*Some GIB® Performance Systems may require different fastener lengths and types. Refer to the applicable GIB® System literature for more information.

Timber Frame – Horizontally Fixed

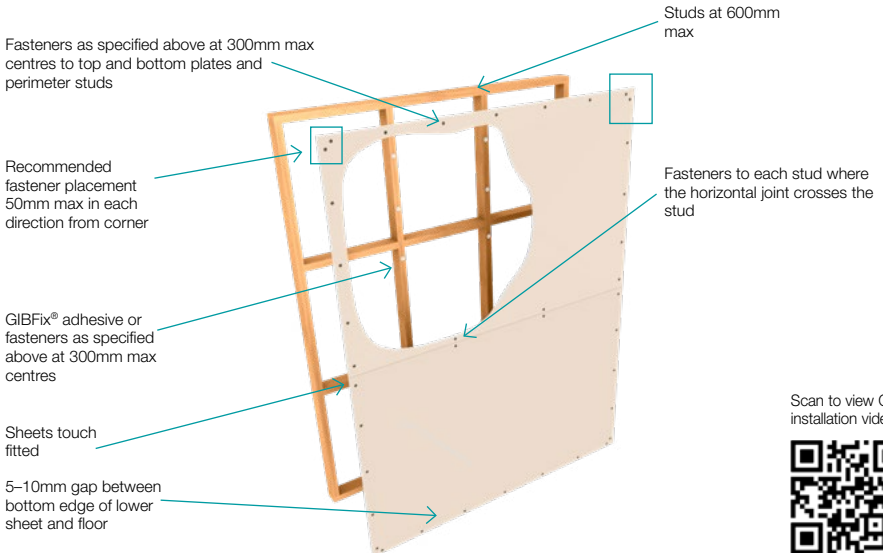

Scan to view GIB® installation videos



5.3 GIB® PLASTERBOARD INSTALLATION – WALLS

For installation guidance on GIB EzyBrace® and GIB Aqualine® Wet Area Systems refer to the GIB® Performance Systems section.

For all other GIB® Performance Systems refer to the relevant GIB® systems literature.

5.3.2 Timber Frame – Vertically Fixed

Wall Framing

- Framing dimensions, spacings and nog requirements must comply with NZS3604:2011
- Timber moisture content must not exceed 18% (see p.34)

Fasteners

- 10mm GIB® plasterboard, minimum 25mm x 6g GIB® Grabber® high thread screws*
- 13mm GIB® plasterboard, minimum 32mm x 6g GIB® Grabber® high thread screws*

Installation

- 300mm max centres around sheet perimeter
- Place fasteners no closer than 12mm from paper bound sheet edge or 18mm from any cut edge
- Fasteners at wall corners to be placed 50mm max in from the corner in each direction
- Do not place GIBFix® adhesive at sheet edges or within 200mm of fasteners
- Place daubs of GIBFix® adhesive 300mm max centres to intermediate studs
- Sheet edges at door or window openings can be adhesive fixed unless forming part of the perimeter of a bracing element
- Butt joints to be on framing or back-blocked
- Fasteners to be positioned no closer than 25mm from each other

Stopping

- Refer to the Jointing and Finishing section (p.86)

*Some GIB® Performance Systems may require different fastener lengths and types. Refer to the applicable GIB® System literature for more information.

Timber Frame – Vertically Fixed

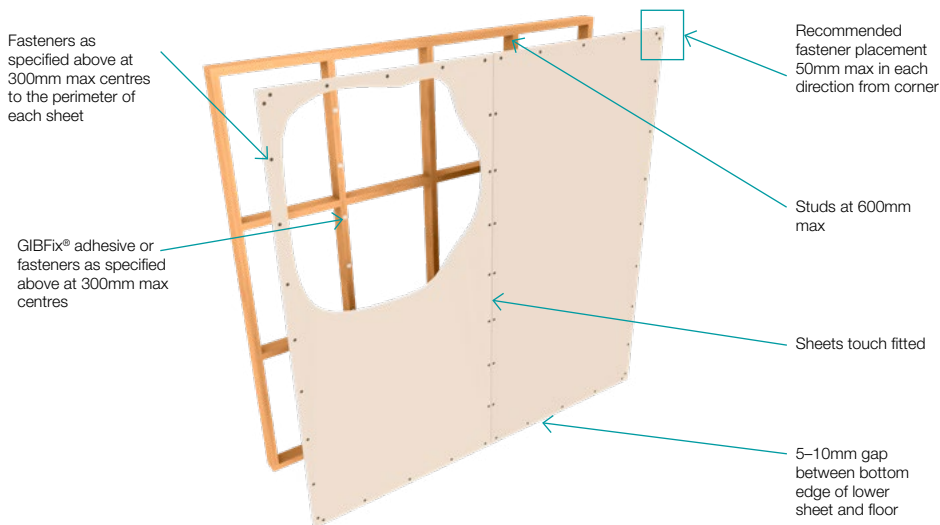

5.3 GIB® PLASTERBOARD INSTALLATION – WALLS

For installation guidance on GIB EzyBrace® and GIB Aqualine® Wet Area Systems refer to the GIB® Performance Systems section.

For all other GIB® Performance Systems refer to the relevant GIB® systems literature.

5.3.3 Steel Frame – Horizontally Fixed

Metal framing to which GIB® plasterboard is fixed must be in accordance with AS/NZS 4600 or NASH Standard. The lining thickness for specific design steel framing systems can be determined by the designer as a component in the system.

For other light steel framing application a minimum thickness of 13mm GIB® plasterboard must be used.

Wall Framing

- Steel stud dimensions to be min. 64 x 34 x 0.50mm nominal with a 6mm return
- Steel channel dimensions to be min. 64 x 30 x 0.50mm nominal
- Studs must be spaced at 600mm centres maximum
- Ensure that the studs are placed with the open side facing in the same direction (see diagram p.45)

Fasteners

- 13mm GIB® plasterboard, minimum 25mm x 6g GIB® Grabber® fine thread self tapping screws*

Installation

- 300mm max to top and bottom channels and end studs
- Pairs of single fasteners to each stud where horizontal joint crosses
- Place fasteners no closer than 12mm from paper bound sheet edge or 18mm from any cut edge
- It is recommended that fasteners at wall corners be placed 50mm max in from the corner in each direction
- Do not place GIBFix® adhesive at sheet edges or within 200mm of fasteners
- Place daubs of GIBFix® adhesive at 300mm max centres to intermediate studs
- Sheet edges at door or window openings can be adhesive fixed unless forming part of the perimeter of a bracing element
- Butt joints to be on framing or back-blocked
- Fasteners to be positioned no closer than 25mm from each other

Stopping

- Refer to the Jointing and Finishing section (p.86)

*Some GIB® Performance Systems may require different fastener lengths and types. Refer to the applicable GIB® System literature for more information.

Steel Frame – Horizontally Fixed

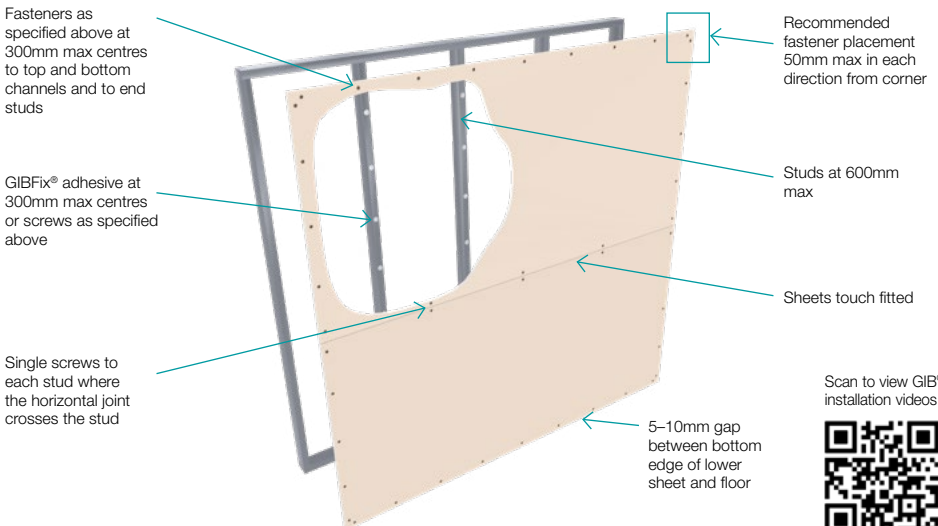

5.3 GIB® PLASTERBOARD INSTALLATION – WALLS

For installation guidance on GIB EzyBrace® and GIB Aqualine® Wet Area Systems refer to the GIB® Performance Systems section.

For all other GIB® Performance Systems refer to the relevant GIB® systems literature.

5.3.4 Steel Frame – Vertically Fixed

Metal framing to which GIB® plasterboard is fixed must be in accordance with AS/NZS 4600 or NASH Standard. The lining thickness for specific design steel framing systems can be determined by the designer as a component in the system.

For other light steel framing application a minimum thickness of 13mm GIB® plasterboard must be used.

Wall Framing

- Minimum steel stud dimensions to be min. 64 x 34 x 0.50mm nominal with a 6mm return
- Steel channel dimensions to be min. 64 x 30 x 0.50mm nominal
- Studs must be spaced at 600mm centres maximum
- Ensure that the studs are placed with the open side facing in the same direction (see diagram p.45)

Fasteners

- 13mm GIB® plasterboard, minimum 25mm x 6g GIB® Grabber® fine thread screws*

Installation

- 300mm max to centres around sheet perimeter
- Place fasteners no closer than 12mm from paper bound sheet edge or 18mm from any cut edge
- It is recommended that fasteners at wall corners be placed 50mm max from the corner in each direction
- Do not place GIBFix® adhesive at sheet edges or within 200mm of fasteners
- Place daubs of GIBFix® adhesive at 300mm max centres to intermediate studs
- Sheet edges at door or window openings can be adhesive fixed unless forming part of the perimeter of a bracing element
- Butt joints to be on framing or back-blocked
- Fasteners to be positioned no closer than 25mm from each other

Stopping

- Refer to the Jointing and Finishing section (p.86)

*Some GIB® Performance Systems may require different fastener lengths and types. Refer to the applicable GIB® System literature for more information.

Steel Frame – Vertically Fixed

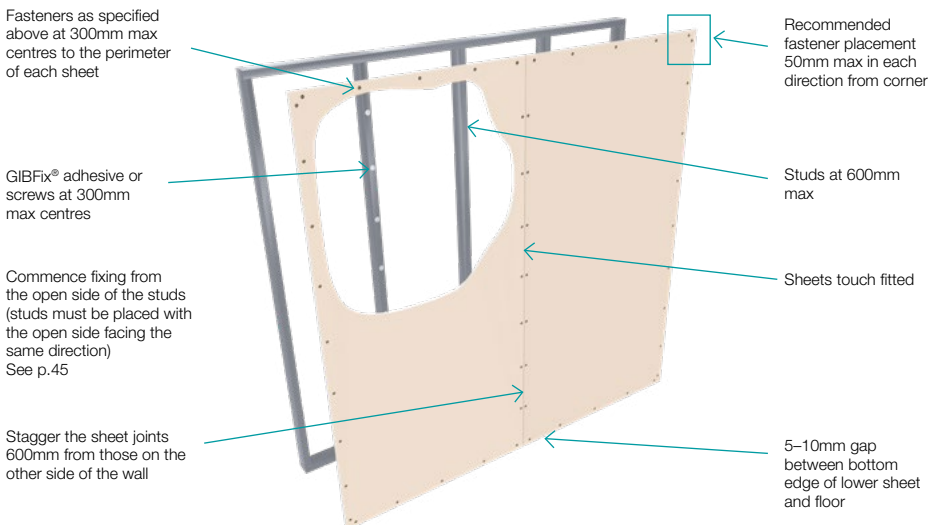

5.3.5 Fastening to Metal Studs

Correct Method

As the face of a steel stud can deflect initially, the correct sequence of attaching the plasterboard is important. The first sheet is attached to the open side of the stud which will cause minor deflection but will pull back tight against the sheet when the screw is fully tightened.

When the second sheet is fixed there will be minimal deflection as the open flange is now supported by the previous sheet.

Support the stud to avoid twisting.

Fastening GIB® Plasterboard to Metal Studs

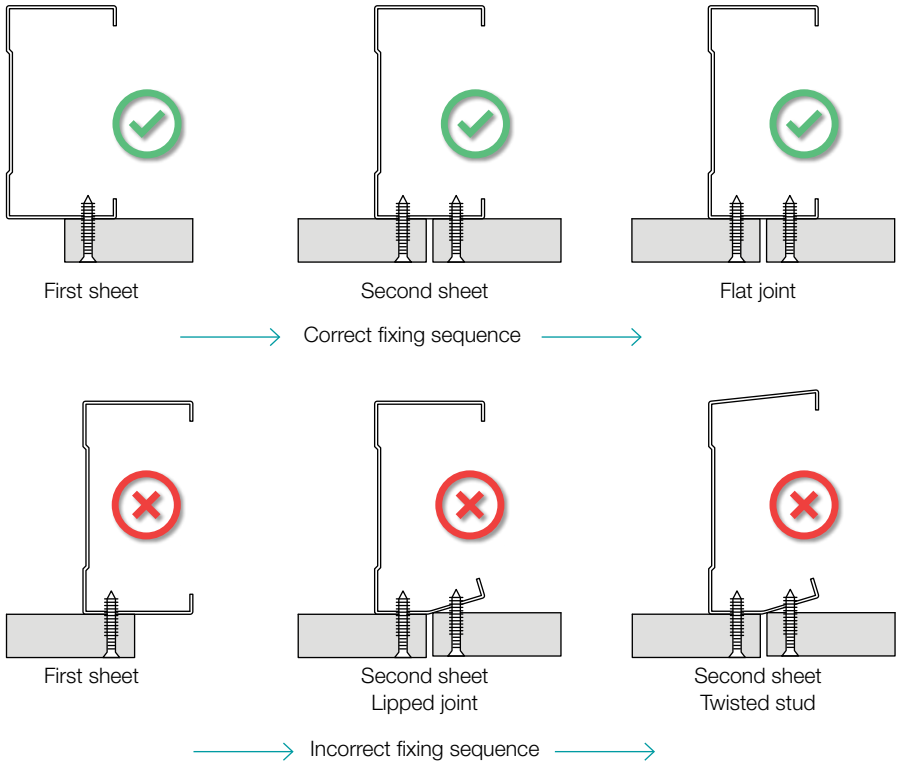

Incorrect fixing method can result in lipped joints, twisted studs and misalignment of the wall.

Scan to view GIB® installation videos



5.3.6 Grooved Jambs and Architraves

Architraves make best practice fixing of plasterboard much simpler. If the use of grooved jambs is unavoidable here is some information to help minimise plasterboard fixing problems.

Grooved door jambs and window liners are an integral part of the New Zealand building scene. Their use means that additional joints may need to be used. Installation of grooved jambs is subject to workmanship skills. Unless the jambs are correctly set up and installed, with a 1–2mm clearance for the plasterboard, it is difficult to install the plasterboard effectively.

When using grooved jambs the following rules should be followed.

The groove must be at least 1–2mm wider than the board that is being used.

Trying to get a 10mm plasterboard into a 10mm groove will be difficult.

Line the back of the groove up with the face of the substrate.



Correct installation of grooved jambs using an 11–12mm packer.

Grooved Jambs and Architraves

Summary

- Grooved jambs are designed to be quick and easy to install. Unless they are installed correctly, they can cause delays in plasterboard fixing and remedial work due to poorly positioned joints
- Unless a small amount of time and effort is invested in getting the unit set up correctly, grooved jambs and liners can cause far more problems than they are worth
- Simple best practice carpentry techniques are all that is required to install units accurately
 - Accurate measuring and ordering by the building contractor
 - Accurate fabrication by the joinery manufacturer
 - Careful installation by the installer

Architraves Option

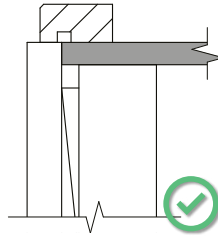

Recommended

Grooved Jamb Option

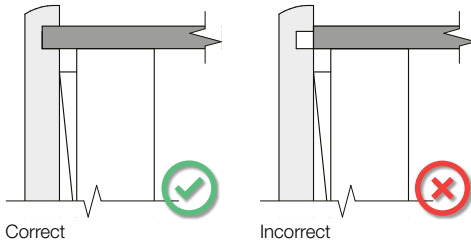

DO NOT place the tapered edge of a sheet into the groove. This requires unnecessary additional stopping.

5.3.7 Reducing Joints When Using Grooved Jambs

- Line the wall with the opening before lining any adjacent walls
- Joinery must be accurately installed to give 1.5–2mm clearance for sheet into the groove (see p.46)
- Groove depth should be 8mm minimum
- Cut lower sheet 20mm less than overall wall length
- Measure from wall or floor to outer edge of joinery frame (not into groove)
- Cut lower sheet as shown in Fig. 2
- Install sheet by placing against the wall and sliding and lifting into grooves as required

- Repeat the procedure for the upper sheet. Measure D from the top edge of the fixed lower sheet to the top outer edge of the window frame. Deduct 6mm from this measurement

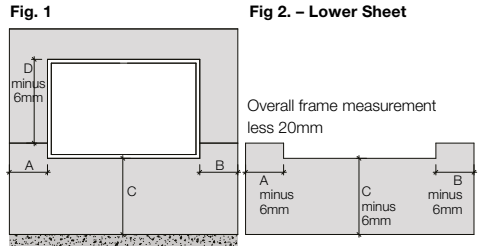

5.4 INSTALLATION TO CEILINGS

5.4.1 General Installation

Truss dimensions and spacings must comply with NZS3604:2011.

The use of GIB® Rondo® metal ceiling battens is strongly recommended. Timber battens can be prone to conditions that contribute to joint failure and popped fasteners. If using timber ceiling battens, additional care needs to be taken to ensure that the moisture content is 18% or less. (see p.34)

To limit sag, loads on GIB® plasterboard ceilings must not exceed an insulation weight of 4.2kg/m², and a fixture weight of 1kg or more unless they are independently supported. The placement of ceiling fixtures such as light fittings are to be limited to one fixture per m² unless independently supported.

Winstone Wallboards recommends:

- 13mm GIB® plasterboard on GIB® Rondo® steel battens at 600mm max centres
- Ceiling battens are installed after the roof framing is complete and the roof has been loaded
- All ceiling sheets be fixed at right angles to the ceiling framing. Sheets must not be fixed in the same direction as the framing to which it is attached. All ceiling battens in a single area need to run in the same direction to enable this. Sometimes this will require additional nogs to be fitted between trusses. Failure to do this will result in a tapered edge/cut edge joint at a point that is highly susceptible to cracking

General Ceiling Installation



Additional nogs may be required in this area

Recommended

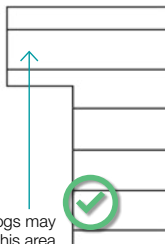

Not Recommended

- more prone to cracking

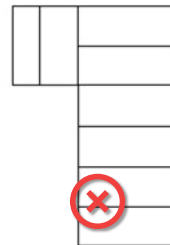

Scan to view GIB® installation videos



5.4.2 Standard Ceiling Fixing

This information applies to the general installation of GIB® plasterboard. If bracing, fire or noise control is a consideration consult the relevant GIB® Systems literature.

Ceiling Framing

- If using timber ceiling battens, timber moisture content must not exceed 18% prior to lining (see p.34)
- Battens should all run in the same direction within a ceiling area. Additional noggs may be required to achieve this

Batten Spacing

- 10mm GIB® plasterboard – 450mm maximum
- 13mm GIB® plasterboard – 600mm maximum
- Winstone Wallboards recommends the use of 13mm GIB® plasterboard in ceiling applications for optimal performance

Fasteners

Metal Battens

- Minimum 25mm x 6g GIB® Grabber® fine thread self tapping screws*

Timber Battens

- Minimum 32mm x 6g GIB® Grabber® high thread screws*

Fastener Spacings

- Single screws at the edges and centre of the sheet across the batten
- Single screw at 600mm max to the perimeter of the ceiling. See p.74 for ceiling diaphragm installation
- Place fasteners no closer than 12mm from a taper sheet edge or 18mm from a cut sheet edge

Adhesive

- Place daubs of GIBFix® adhesive at max 200mm to intermediaries
- Do not place adhesive at sheet edges or within 200mm of fasteners

Lining

- Sheets should be touch fitted
- Sheets must be fixed at right angles to the ceiling framing unless otherwise specified in GIB® Performance System specifications

Stopping

- Refer to the Joint and Finishing section (p.86)

*Some GIB® Performance Systems may require different fastener lengths and types. Refer to the applicable GIB® System literature for more information

Ceilings

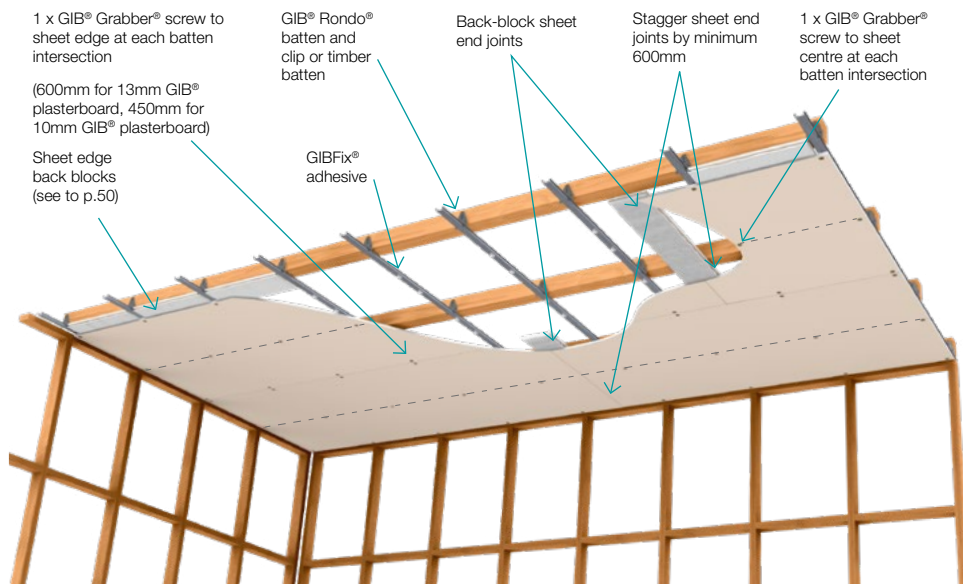

5.4.3 Raking Ceilings and Skillion Roofs

Due to the higher temperatures and low air movement that can occur in raking ceilings it is strongly recommended that clip fixed GIB® Rondo® metal battens are used (these are considered to be ceiling suspension systems).

Because of the heat that can be generated in roof spaces, timber battens can be subjected to conditions that contribute to joint failure and popped fasteners.

The use of control joints or perimeter relief will help reduce the risk of cracking in large, expansive ceilings.

These may not be suitable for use in Fire or Noise Control Systems.

Back blocking of all ceiling joints is highly recommended as it can reduce the likelihood of cracking.

Fixed – Steel Backing Angle

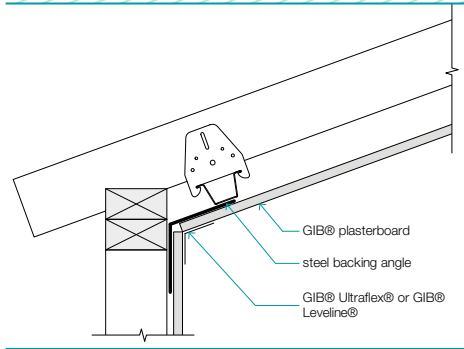

Flexible – Perimeter Relief

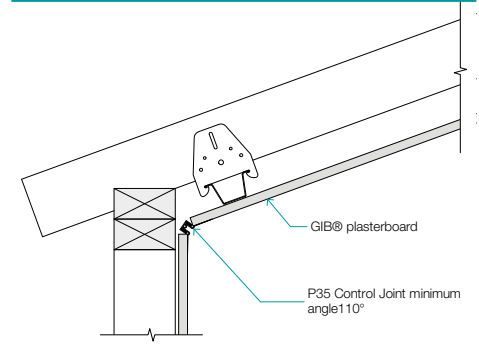
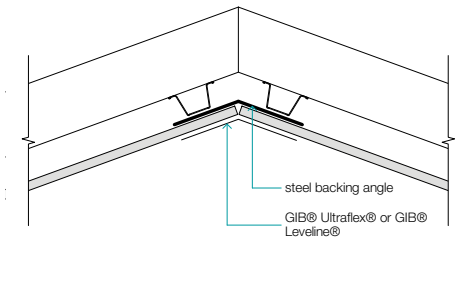
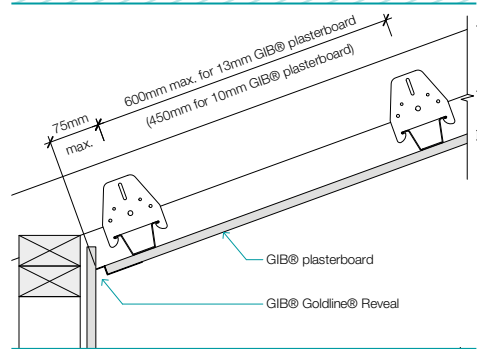

Note: It is recommended that a flexible perimeter relief be used where there is a high risk of movement.

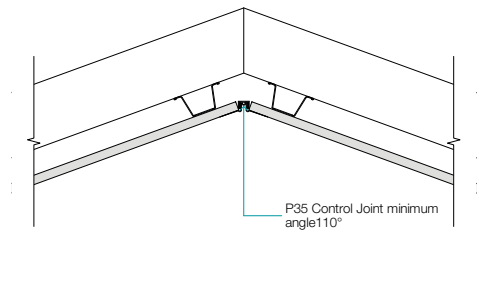

5.4.4 Back Blocking – Butt and Edge Joints

Back blocking is the practice of laminating an off-cut of plasterboard to the back of a joint using GIB-Cove® Bond adhesive.

Back blocking is required to ceiling sheet edge joints as follows:

Timber Battens	When there are 3 or more tapered edge joints in a ceiling area
Metal Battens	When there are 6 or more tapered edge joints in a ceiling area

Back blocking is required to all joints when a Level 5 Finish has been specified.

Back blocking is strongly recommended at sheet end joints in ceilings. Some fire rated systems require that joints are made on solid blocking and that requirement takes precedence and must be followed. Refer to GIB® Fire Rated Systems specifications for more information.

Back blocking is not required for a Level 4 Finish when a suspension system has been used. This includes GIB® Rondo® metal ceiling batten system fixed on clips. See p.49. Sheets ends should be back blocked.

Due to wind pressure when garage door is open, and vibration from garage door opening, it is recommended that all sheet joints in garage ceilings are back blocked.

Back Blocking Comprises 2 Steps:

- Laminating a piece of plasterboard to the back of the joint
- Forming a tapered edge to help form a flat stopped joint

Step 2 can be omitted but the stopped joint will need to be much wider (500–600mm) in order to minimise the effect of the stopped joint thickness.

Back Blocking Technique

- Make back blocks at least 300mm wide and cut to fit loosely between framing members
- Apply GIB-Cove® Bond to the underside of the back block with a 6–8mm notched trowel
- Do not use synthetic wall board adhesive for back blocking
- If possible, attach the back block to the back of the joint from above
- If access from above is not possible, apply GIB-Cove® Bond to one half of the back block before attaching the back block to the edge of the sheet. Install a couple of screws through the tapered edge to secure the back block
- Apply GIB-Cove® Bond to the remainder of the back block just before fixing the next sheet

Back Blocking

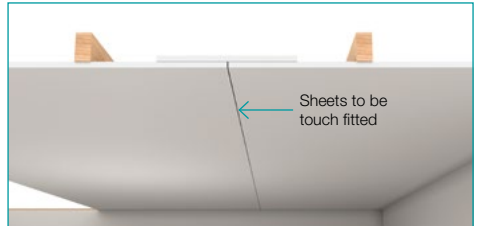
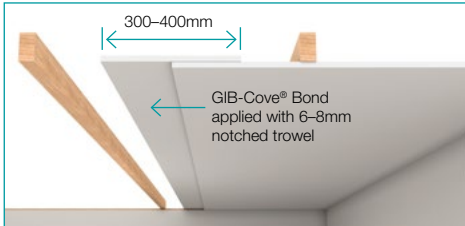

Creating a Tapered Edge

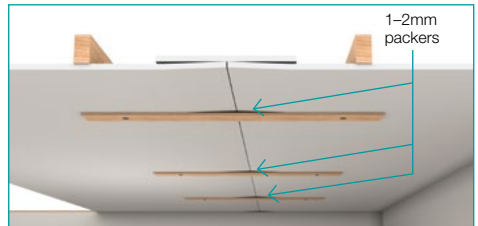

5.4.5 Control Joints – Walls and Ceilings

Control joints relieve stress due to movement of dissimilar materials when subjected to change in temperature and humidity. The joint positions are designed to accommodate such minor movements but do not allow for significant timber drying shrinkage or structural deformations such as may result from high wind or earthquake forces.

Walls

- In long unbroken partitions or wall runs, control joints are required at maximum 12 metre centres in either direction*
- They are also required where structural control joints occur in the primary structure
- Door frames extending from floor to ceiling constitute effective control joints in either direction*

Ceilings

- Extensive ceiling areas must have control joints spaced at maximum 12 metre centres in either direction*
- It is recommended joints be positioned to intersect lighting fixtures, heating vents or air diffusers or at junctions of corridors with open areas

Other situations

- Where GIB® plasterboard meets dissimilar materials, it is recommended to isolate using an edge trim, casing bead or control joint
- Control joints may also be required to match other building movement joints and closer spacing may be required to provide seismic relief and minimise the risk of lining damage following an earthquake (check with building designers)

- Special detailing is required where control joints are detailed in GIB® performance systems such as fire rated, bracing or noise control systems or a ceiling diaphragm (for further information phone the GIB® Helpline 0800 100 442)
- In stair wells and high timber framed walls, provision can be made for timber movement by installing a control joint or alternatively leaving a 20mm gap between the plasterboard sheets at the midfloor. This gap may be covered by a suitable cover batten

*Reference AS/NZS 2589: 2017- 3.4

Maximum Centres	Joint Control
12 metres	Walls
12 metres	Ceilings

Perimeter relief using GIB® Goldline® Tape-On Trims

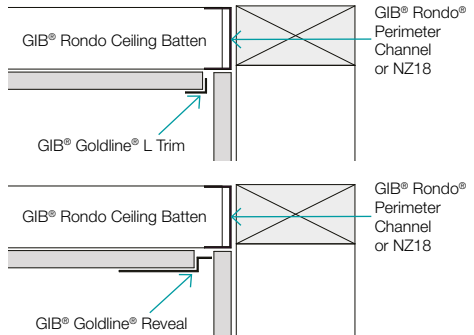

Control Joints in Ceilings – Recommendations to Reduce Risk of Cracking

There are some common places within the 12m spacing where cracks are most likely to occur in ceilings (as shown below). It is recommended to consider installing control joints in these locations (as shown below) to reduce the risk of cracking.

Where hallways exit from a larger ceiling area.

Plan view

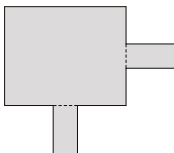

At internal corners in irregular shaped ceilings or where the main ceiling would look better divided into smaller sections.

Plan view

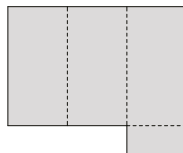

At openings such as skylights, voids or recessed strip lighting. This may also include designated functional areas of a space.

Plan view

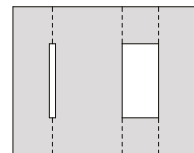

5.4.6 Control Joint Installation Details

GIB® Rondo® P35 control joint

- Allow an 18mm minimum gap between the plasterboard sheets
- Locate the GIB® Rondo® P35 control joint centrally in the gap. Staple both flanges to the lining at 150mm centres maximum
- Finish with jointing compound using the channel ribs as screeding guides
- When the joint is dry remove the protective tape

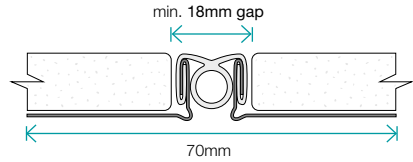

Control joint using GIB® Goldline® Platinum trim

- Allow a 14–17mm gap between the plasterboard sheets
- Install GIB® Goldline® Platinum GR reveal to one side of joint
- Install GIB® Goldline® L-Trim to the other side. Use a spacer to provide an even gap between the trim. This can be between 3–12mm
- Apply compounds as described on p.91-92

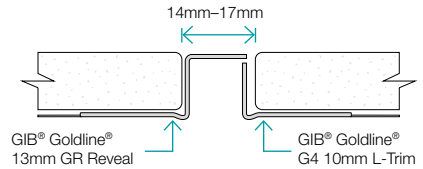

GIB® Plastic W-profile Control Joint

- Discrete finish and has tear-away tabs for easy installation
- This trim is thicker than the other control joint trims and thus may have implications for the final joint height
- Available in 3.0m lengths

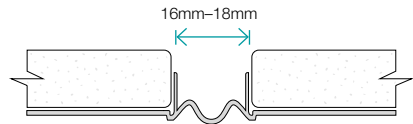

Note: Contact the GIB® Helpline 0800 100 442 for detailing of control joints in GIB® Performance Systems (e.g. fire, noise, bracing).

GIB® Rondo® Steel Battens

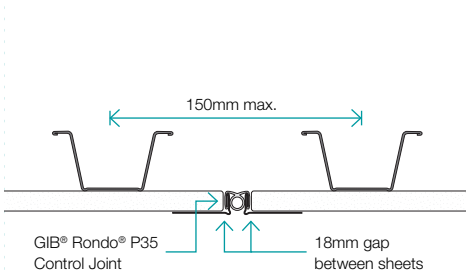

Timber Stud Walls

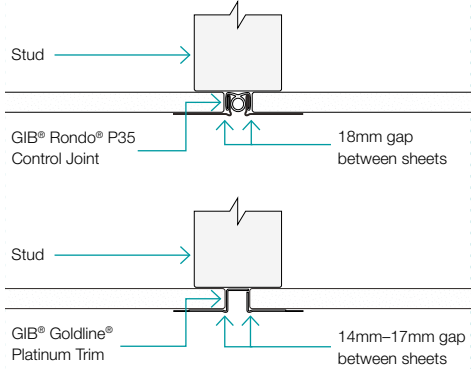

Two Storey Full Height Wall with Expansion Joint

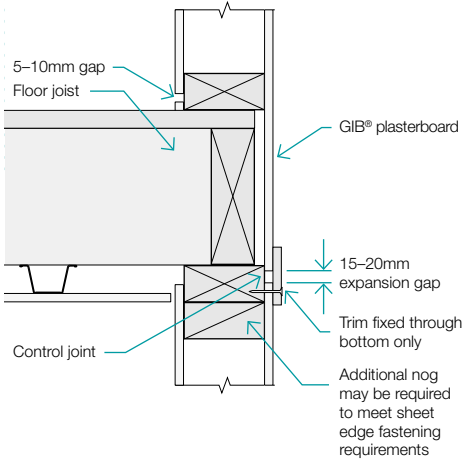

Masonry Junction Timber or Steel Framing

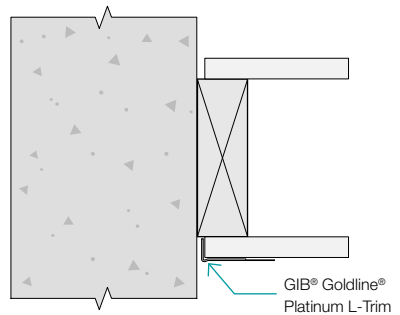

Where control joints are to be used in GIB® Fire Rated Systems refer to the GIB® Fire Rated Systems Manual for technical guidance.



5.4.7 GIB® Rondo® 310 Metal Batten System Installation Instructions

The GIB® Rondo® 310 system forms a strong, stable and flat substrate for ceilings in residential and commercial applications. The 35mm dimension allows it to be directly substituted into ceilings where 35mm timber battens would traditionally have been used. Consult an electrical contractor for any earthing requirements that may need to be incorporated.

There are two methods of fixing GIB® Rondo® 310 metal battens.

Recommended method

Clipped using either:

- 311D clip for a drop of 0–30mm
- 313 clip where a larger drop is required between the bottom of the truss chord, joist or rafter and the back of the ceiling batten. A drop of up to 130mm can be achieved in

order to accommodate services or variations in framing heights

- GIB Quiet Clip® in GIB Noise Control® Systems

Alternative method

- Directly by fastening with pairs of min. GIB® Grabber® 32mm x 8g wafer head screws through the flange
- Alternatively pairs of min. 45mm x 2.8mm flat head nails can be used
- For fixing to steel framing a drill tip screw is recommended

Note: If the 310 system is to be used in a ceiling diaphragm the batten needs to be screwed directly through the flanges to the framing.

See detail on p.75

GIB® Rondo® 310 System

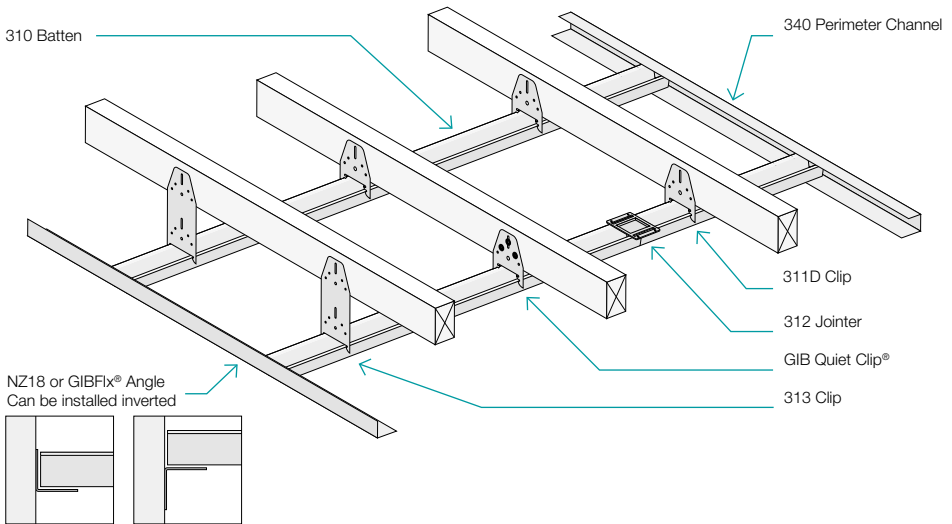

For ceiling diaphragm details refer to p.74

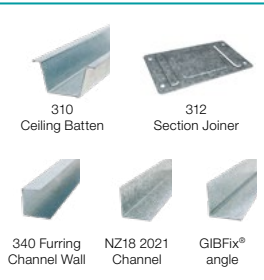
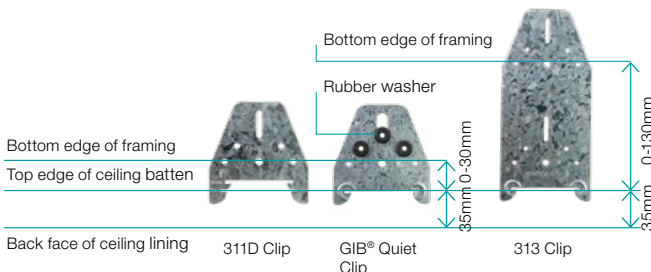

GIB® Rondo® 310 System

Recommended Best Practice Details

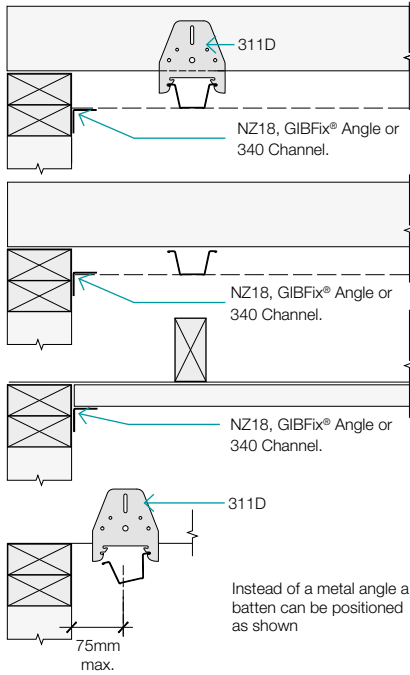

Other Details

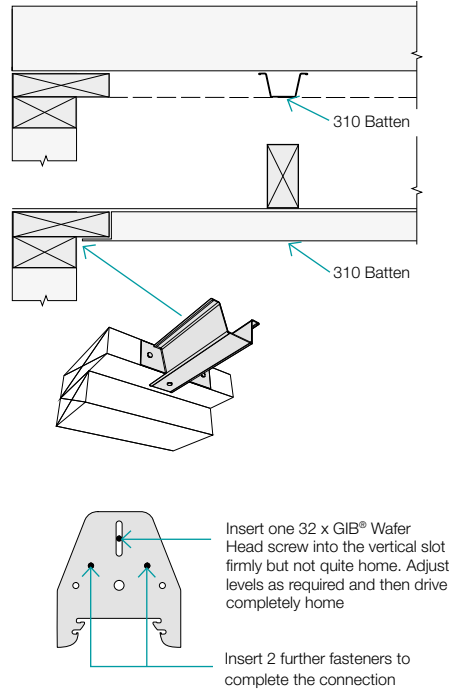

- Establish a datum line for the ceiling
- Place a string line on the datum line at right angles to the battens, under the truss or joist closest to the centre of the room
- Install GIB® Rondo® clips at 600mm centres (450mm for 10mm GIB® plasterboard) using the string line to establish the correct position

- Cut the batten to the required length using snips or a hacksaw
- Insert the batten into the channel at each end and fit into the clip
- Install remainder of clips ensuring that the batten is straight and flat

GIB® Rondo® 310 Batten Span Table for Residential Internal Applications

GIB® Plasterboard Thickness – Single layer	10mm	13mm
Maximum Batten Spacing (mm)	450	600
Multi Span (mm)	1200	
Single Span and Garages (mm)	900	

Battens

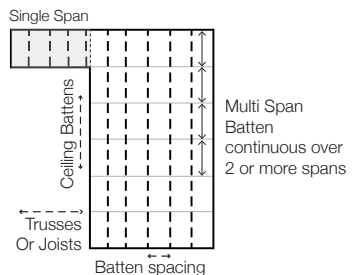



5.4.8 GIB® Rondo® 308 Metal Batten System Installation Instructions

The GIB® Rondo® 308 system is a lightweight yet very strong ceiling batten. In addition to its function as a ceiling batten it can also be used as a wall furring channel and is an integral part of GIB Noise Control® Systems for walls. Consult an electrical contractor for any earthing requirements that may need to be incorporated.

Recommended Method

The GIB® Rondo® 308 system is installed using either:

- 226 clip for a drop of 0–30mm
- 394 clip where a larger drop is required between the bottom of the truss chord, joist or rafter and the back of the ceiling batten. Up to 130mm clearance between the bottom of the framing and the back of the batten of can be achieved in order to accommodate services or variations in framing heights

Note: If the 308 system is to be used in a ceiling diaphragm, the batten needs to be secured directly to the framing (see p.75).

GIB® Rondo® 308 System

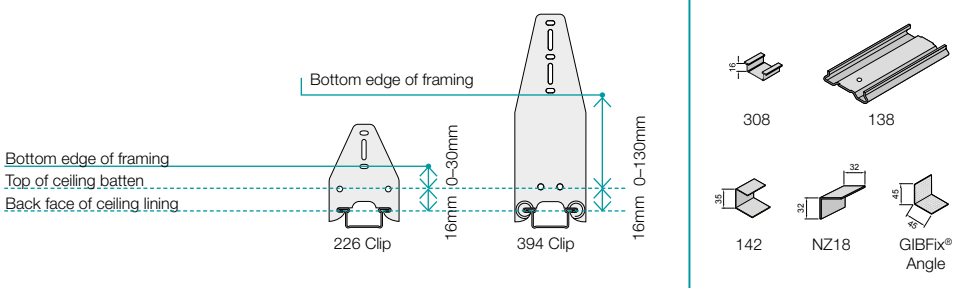
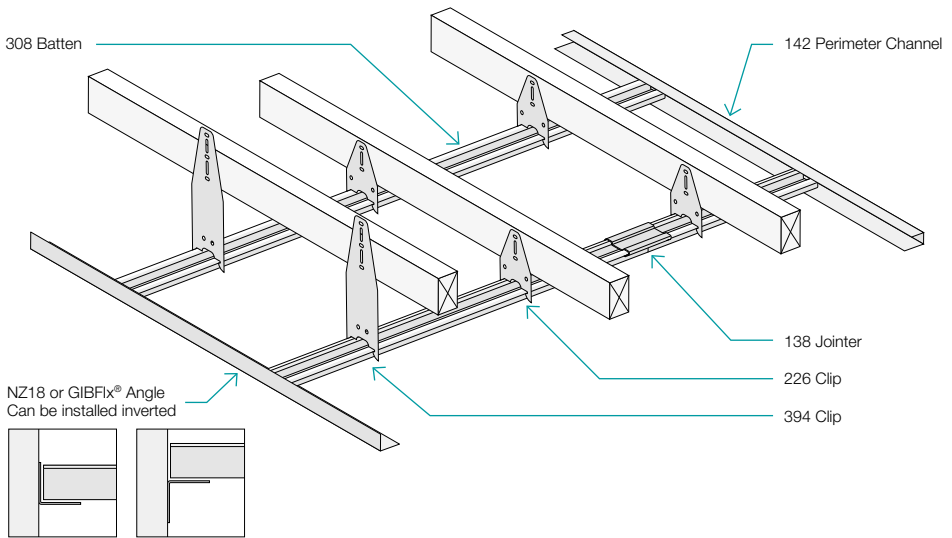

GIB® Rondo® 308 System

Recommended Best Practice Details

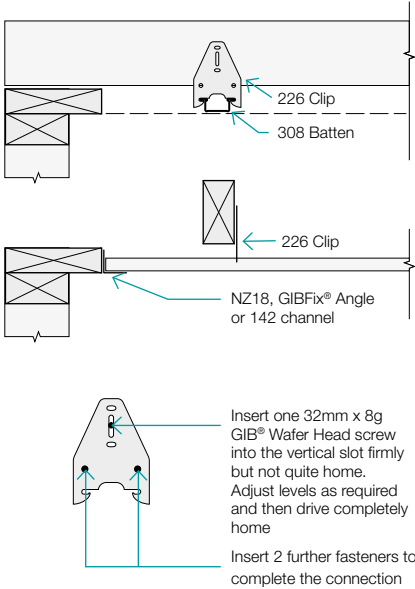

Other Details

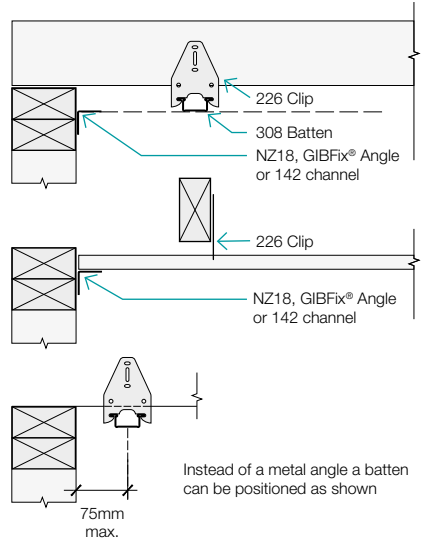

- Establish a datum line for the ceiling
- Place a string line on the datum line at right angles to the battens, under the truss or joist closest to the centre of the room
- Install GIB® Rondo® clips at 600mm centres (450mm for 10mm GIB® plasterboard) using the string line to establish the correct position

- Cut the batten to the required length using snips or a hacksaw
- Insert the batten into the channel at each end and fit into the clip
- Install remainder of clips ensuring that the batten is straight and flat

GIB® Rondo® 308 Batten Span Table for Residential Internal Applications

GIB® Plasterboard Thickness – Single layer	10mm	13mm
Maximum Batten Spacing (mm)	450	600
Multi Span (mm)	1200	
Single Span and Garages (mm)	900	

Battens

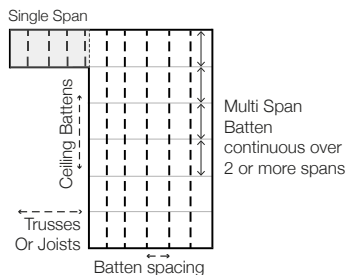



5.4.9 GIB® Rondo® Suspended Ceiling System

The range of GIB® Rondo® suspended ceiling componentry provides additional clearance above the ceiling level. This could be to run electrical, plumbing or ventilation equipment. The system allows for the ceiling lining material to be directly attached to the lower face of the battens.

This is not to be confused with a two way grid system which accommodates proprietary ceiling tiles. The components can be assembled in a wide range of combinations to suit a variety of applications. Refer to GIB® Rondo® System literature for more information.

GIB® Rondo® Suspended Ceiling Components

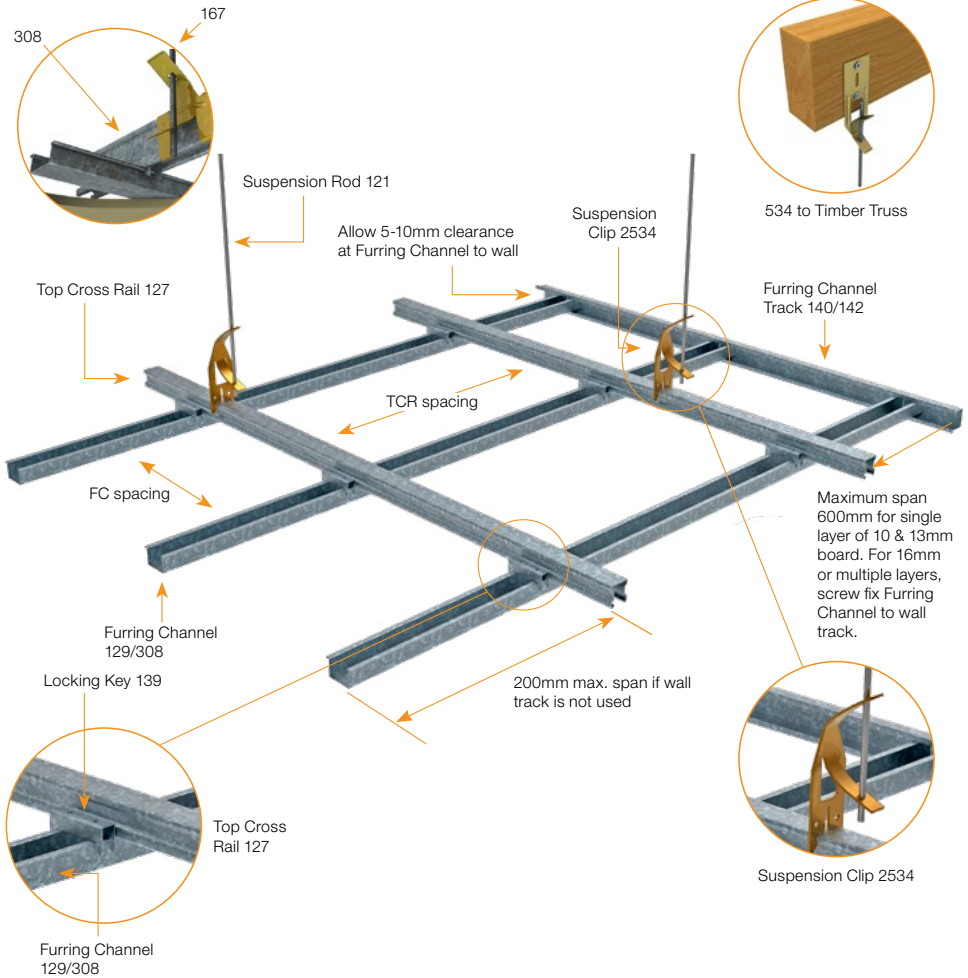

5.5 CURVING GIB® PLASTERBOARD

GIB® plasterboard can be curved. Curvature is dependent on the thickness and whether the board is applied wet or dry.

The radii shown below are for:

GIB Standard, GIB Ultraline®, GIB Braceline®/Noiseline®, GIB Weatherline®, GIB Fyreline®, GIB Aqualine® and GIB X-Block®.

It is not recommended to curve thicker and some

high density boards such as 16mm and 19mm GIB Fyreline®, GIB Toughline®, GIB Toughline® Aqua and GIB Barrierline® due to the risk of breakage.

Curved walls can be incorporated into performance systems provided the curving is carried out strictly in accordance with the application method detailed below.

Minimum Bending Radii of GIB® Plasterboard

Board Thickness/ Type	Minimum Radius (Wet)*	Minimum Radius (Dry)
10mm GIB® Plasterboard**	1000mm	1200mm
13mm GIB® Plasterboard***	1200mm	1500mm

*Not applicable to GIB Weatherline® and GIB Aqualine®

**Includes 10mm GIB Weatherline®

***Includes 13mm GIB Weatherline® but excludes 13mm GIB Toughline® and GIB Toughline® Aqua

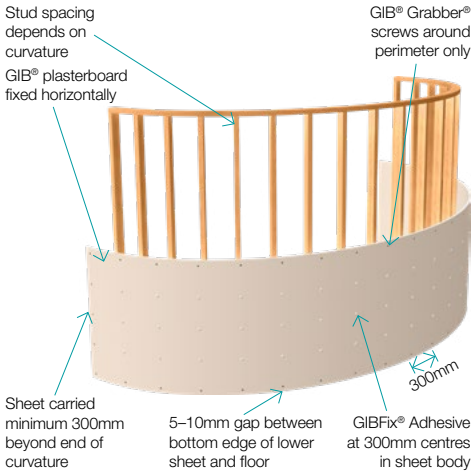

Application Method

- Ensure that framing spacings in the table above are correct
- Sheets must be fixed horizontally to walls
- If possible, select board length to allow for one unbroken panel to cover the entire curve with enough extra length to extend 300mm beyond each end
- When curving 'wet', apply water with a paint roller to both sides. Approximately 40 mL/m² of water and 10 minutes set time are required
- When creating an outside curve, begin installation at one end and fasten the sheet as it is wrapped around the curve

Framing Centres

Wall or Ceiling Radius	Maximum Stud, Batten or Joist Spacing
900mm - 1200mm	200mm
1200mm - 3000mm	300mm
3000mm - 4000mm	400mm
Over 4000mm	600mm (450mm for 10mm GIB® Plasterboard in ceiling applications)

The projection of a curved GIB EzyBrace® bracing element should be used as the effective wall length, as illustrated below.

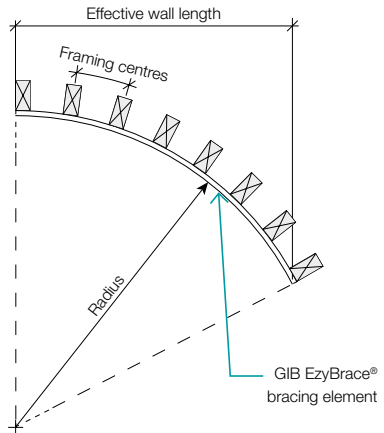

- When creating an inside curve, start fastening the sheet at the centre of the curve and work outwards to the end of the sheet

The development work found that curving GIB® plasterboard requires patience. Rushing the curving process can result in board breakages. Taking your time and allowing the board to take the curve is the best approach. The typical time taken to successfully fit a board to a curve is 30 - 40 minutes.

Note: Lining the inside of the curve will be more difficult than lining the outside. This will require additional labour and the GIB® plasterboard must be curved prior to installation.

5.6 FIXING TO MASONRY

Direct bonding of GIB® plasterboard to concrete or brick masonry walls must only be considered when the concrete or masonry substrate is thoroughly dry and adequately protected against moisture penetration.

The substrate must be firm, dry, and free of dust, grease, release agents and curing compounds.

In situations where dampness or rain penetration problems exist, corrective measures must be taken prior to installation of interior linings.

Movement and control joints in the main structure must be carried through the GIB® plasterboard linings. This can be achieved by installing a control joint in the plasterboard.

Direct Bonding (For Sheet Heights up to 3m)

- Determine the sheet position for either vertical or horizontal fixing and mark on wall
- GIB® plasterboard sheets can be fixed vertically or horizontally. Horizontal fixing creates fewer joints and is recommended
- Use GIB-Cove® Bond to bond the GIB® plasterboard to concrete or masonry surfaces
- Mix GIB-Cove® Bond to a smooth, thick consistency
- Apply GIB-Cove® Bond daubs approximately 50mm diameter x 12mm thick at 300–400mm centres vertically and 500–600mm centres horizontally. Ensure that adhesive is placed no closer than 25mm from the edge of the sheet
- Where irregularities up to 10mm occur on the masonry surface, use larger daubs of adhesive to bridge the gap
- Position the sheet and press into place
- Obtain true alignment and flatness by using a long straight edge over the surface of the sheet
- Alternatively, apply adhesive over the entire back surface of the sheet using a notched trowel
- Apply GIB-Cove® or GIB® Trims to wall and ceiling intersections
- Fix skirting and architrave with masonry nails or adhesive

Daubs approximately 50mm diam. x 12mm high
Daubs placed no closer than 25mm from sheet edge

Control joints in walls need to continue through GIB® plasterboard

GIB-Cove® Bond adhesive daubs at 300–400mm centres vertically and 500–600mm centres horizontally



Wall Strapping must be used:

- Wall Strapping must be used:
 - When the concrete or masonry wall is below ground level
 - When the concrete or masonry wall is an external wall, unless a proprietary external weatherproofing system can be verified as providing weather tightness for the life of the building
 - In bathrooms, laundries and other wet areas
 - When the concrete or masonry substrate or paintwork is in poor condition
 - When the wall surface contains irregularities of more than 8–10mm strapping can be packed to provide a flat surface for the plasterboard
 - For walls in excess of 3.0m in height
- Use either nominally 50 x 25mm timber strapping or metal furring channels. Deeper strapping may be required to accommodate insulation requirements
- Fix DPC behind timber strapping
- Fix strapping vertically to the wall surface at a maximum of 600mm centres, with either a continuous horizontal batten or nogs at the top and bottom of the wall
- Install services prior to installing GIB® plasterboard linings

50 x 25mm KDMG timber or GIB® Rondo® Steel Battens, maximum 600mm apart.

Pack battens as required to provide a flat surface

For vertically fixed boards, use nogs between battens at 800mm centres

Nogs are not required for horizontally fixed boards

DPC behind timber strapping

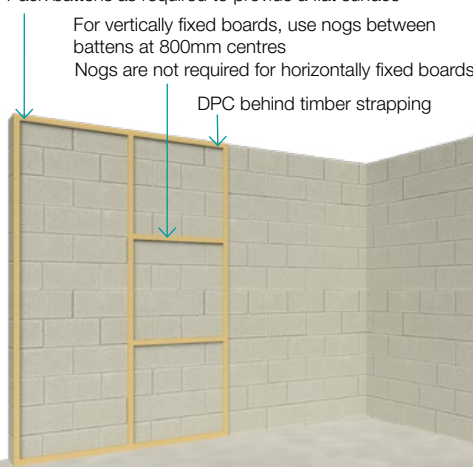

5.6 FIXING TO MASONRY

If insulation is required to concrete or masonry, it is recommended that GIB® Rondo® 308 battens are clipped to GIB® Rondo® A239 clips as

shown. A239 clips should be spaced at 1200mm centres (max) vertically and 600mm centres (max) horizontally.

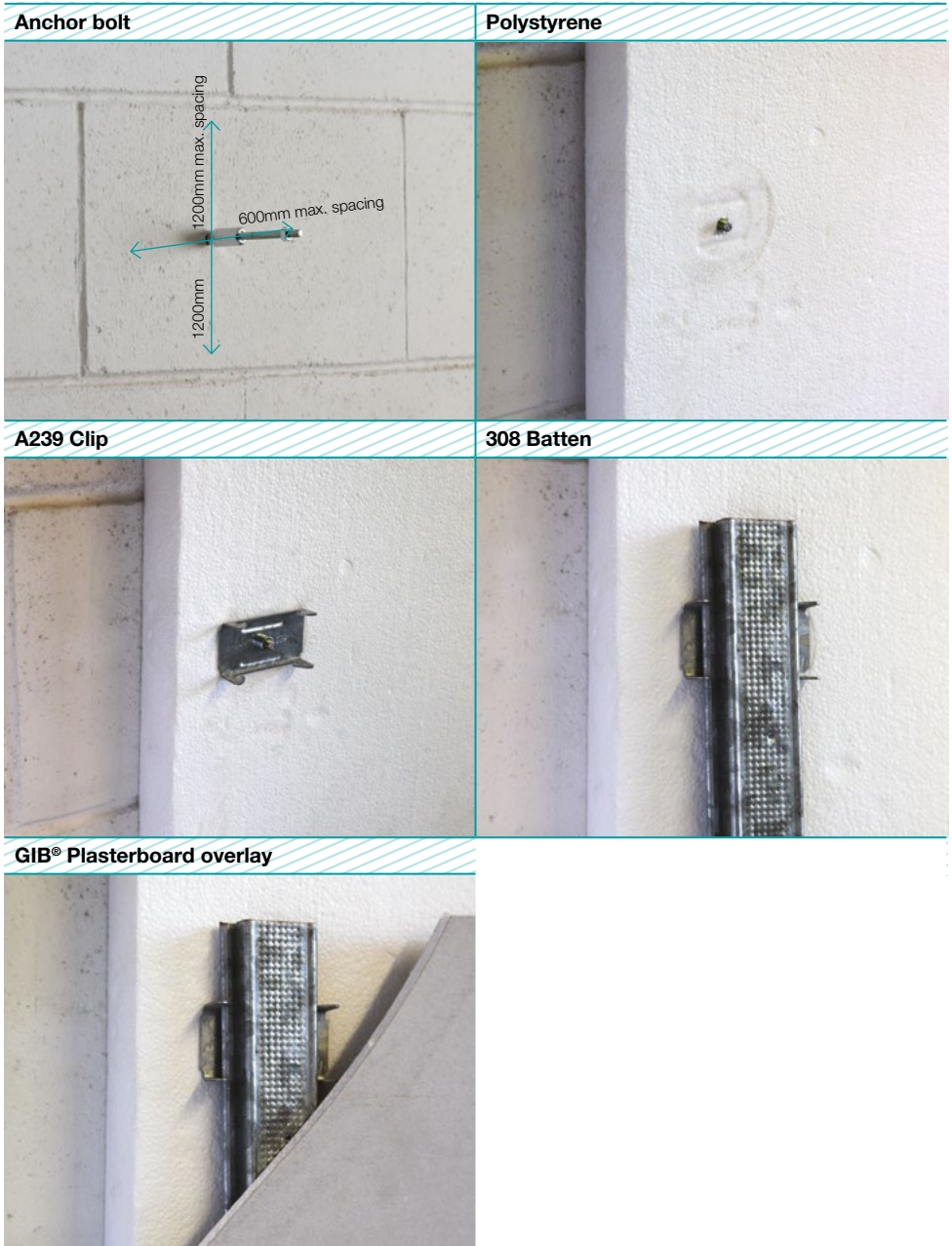



6.0 GIB® PERFORMANCE SYSTEMS

The GIB® Performance Systems section covers installation of GIB EzyBrace® and GIB Aqualine®

Wet Area Systems. For other systems refer to the appropriate GIB® systems literature.

6.1 GIB® BRACING SYSTEMS

This section covers the installation of GIB EzyBrace® Systems to timber framing to NZS 3604:2011. Full design details can be found in the GIB EzyBrace® Systems literature.

Bracing of steel framed walls is by specific design. For assistance refer to the document GIB EzyBrace® for Light Steel Frame Systems available from gib.co.nz or nashnz.org.nz.

GIB® Bracing elements code system:

GS	GIB® Standard plasterboard
BL	GIB Braceline®
W	GIB Weatherline®
P	7mm structural plywood manufactured to AS/NZS 2269:2012
1	Bracing element fixed to one side of the wall only
2	Bracing element fixed to both sides of the wall
N	Panel hold down not required
H	GIB HandiBrac® or metal strap and hold down bolt
NOM	Nominal fixing as per p.41-42

6.1.1 Installation Summary - Internal System Options

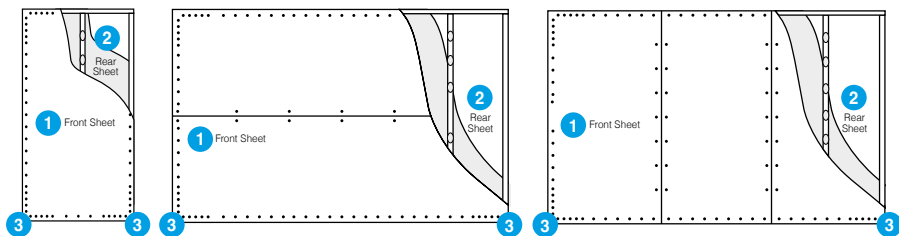

	Front Sheet ①		Rear Sheet ②		Panel Hold-Down Fixings ③	Fastener Spacing
	Lining	Fasteners	Lining	Fasteners		
GS2-NOM	Any 10mm or 13mm GIB® plasterboard	Minimum 32mm x 6g GIB® Grabber® high thread screws	Any 10mm or 13mm GIB® plasterboard	Minimum 32mm x 6g GIB® Grabber® high thread screws	Not Required	Corner fastening pattern as illustrated on p.71. All four corners of GS2-NOM bracing element must be fastened at 50mm max and 250mm max from the edge of the sheet at 300mm max centres
GS1-N	Any 10mm or 13mm GIB® plasterboard	Minimum 32mm x 6g GIB® Grabber® high thread screws	Not Required	Not Required	Not Required	GIB® Plasterboard Corner fastening pattern as illustrated on p.71. Fasteners at 150mm max to bracing element perimeter and: at 300mm max centres to intermediate sheet joints for vertical fixing, or at stud/sheet junction for horizontally fixed elements, and
GS2-N			Any 10mm or 13mm GIB® plasterboard	32mm x 6g GIB® Grabber® high thread screws		
GSP-H			Minimum 7mm structural plywood manufactured to AS/NZS 2269	50mm x 2.8mm flat head galvanised or stainless steel nails	Yes	at stud/sheet junction for horizontally fixed elements, and GIBFix® adhesive daubs at 300mm max are to intermediate framing
BL1-H	10mm or 13mm GIB Braceline®	Minimum 32mm x 6g GIB® Grabber® high thread screws	Not required	Not required		Structural Plywood Fasteners at 150mm max around the perimeter of every sheet and at 300mm max centres to intermediate studs. Place fasteners no closer than 7mm from sheet edges. Plasterboard corner fastener pattern does not apply to plywood
BLG-H			Any 10mm or 13mm GIB® plasterboard	32mm x 6g GIB® Grabber® high thread screws		
BLP-H			Minimum 7mm structural plywood manufactured to AS/NZS 2269	50mm x 2.8mm flat head galvanised or stainless steel nails		

Note: Minimum bracing element length is 400mm

Scan to view GIB® installation videos



6.1.2 Internal Bracing System Specifications

GS2-NOM

1. 10mm or 13mm GIB® Standard plasterboard fixed to each side of the wall framing
2. Corner fastening pattern applies (see p.71)
3. 32mm x 6g GIB® Grabber® screws or GIB® Grabber® Dual Thread screws at 300mm max to perimeter
4. Panel hold downs not required
5. Centre of the sheet may be fixed with adhesive or fastenings at 300mm max
6. Joints must be stopped
7. GIB® tape must be used in joints
8. Sheets may be fixed horizontally or vertically

Bracing Element – Plasterboard side shown

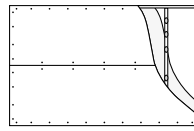

Horizontal Fixing

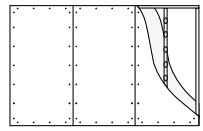

Vertical Fixing

GS1-N

1. Any 10mm or 13mm GIB® plasterboard to one side of the wall only
2. Corner fastening pattern applies (see p.71)
3. 32mm x 6g GIB® Grabber® screws or GIB® Grabber® Dual Thread screws at 150mm max to perimeter
4. Centre of the sheet may be fixed with adhesive or fastenings at 300mm max
5. Panel hold downs not required
6. Joints must be stopped
7. GIB® tape must be used in joints
8. Sheets may be fixed horizontally or vertically

Bracing Element – Plasterboard side shown

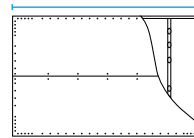

Horizontal Fixing

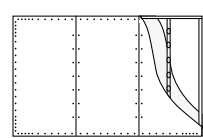

Vertical Fixing

GS2-N

1. Any 10mm or 13mm GIB® plasterboard to both sides of the wall. Both sides fixed as bracing elements
2. Corner fastening pattern applies (see p.71)
3. 32mm x 6g GIB® Grabber® screws or GIB® Grabber® Dual Thread screws at 150mm max to perimeter
4. Centre of the sheet may be fixed with adhesive or fastenings at 300mm max
5. Panel hold downs not required
6. Joints must be stopped
7. GIB® tape must be used in joints
8. Sheets may be fixed horizontally or vertically

Bracing Element – Plasterboard side shown

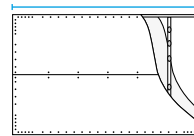

Horizontal Fixing

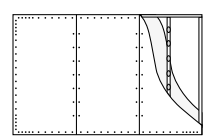

Vertical Fixing

GSP-H

1. Any 10mm or 13mm GIB® plasterboard to one side of the wall
2. 7mm structural plywood to the other side
3. Corner fastening pattern applies (see p.71)
4. 32mm x 6g GIB® Grabber® screws or GIB® Grabber® Dual Thread screws at 150mm max to perimeter (plasterboard side) 50 x 2.8mm FH nails at 150mm max to perimeter. Corner fastening pattern not applicable to plywood side
5. Panel hold downs required
6. Centre of the sheet may be fixed with adhesive or fastenings at 300mm max
7. Joints must be stopped
8. GIB® tape must be used in joints
9. Sheets may be fixed horizontally or vertically

Bracing Element – Plasterboard side shown

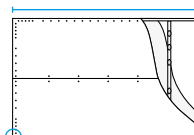

Horizontal Fixing

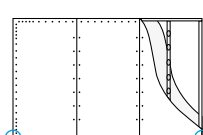

Vertical Fixing

BL1-H

1. 10mm or 13mm GIB Braceline® to one side of the wall only
2. Corner fastening pattern applies (see p.71)
3. 32mm x 6g GIB® Grabber® screws or GIB® Grabber® Dual Thread screws at 150mm max to perimeter
4. Centre of the sheet may be fixed with adhesive or fastenings at 300mm max
5. Panel hold downs required
6. Joints must be stopped
7. GIB® tape must be used in joints
8. Sheets may be fixed horizontally or vertically

Bracing Element – Plasterboard side shown

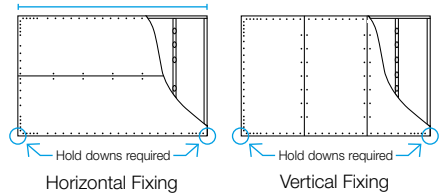

BLG-H

1. 10mm or 13mm GIB Braceline® to one side of the wall
2. Any 10mm or 13mm GIB® plasterboard to the other side. Both sides fixed as bracing elements
3. Corner fastening pattern applies (see p.71)
4. 32mm x 6g GIB® Grabber® screws or GIB® Grabber® Dual Thread screws at 150mm max to perimeter
5. Centre of the sheet may be fixed with adhesive or fastenings at 300mm max
6. Panel hold downs required
7. Joints must be stopped
8. GIB® tape must be used in joints
9. Sheets may be fixed horizontally or vertically

Bracing Element – Plasterboard side shown

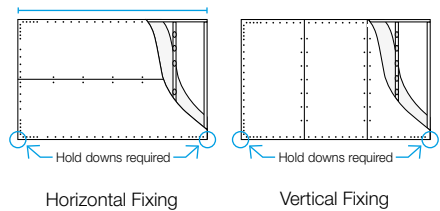

BLP-H

1. 10mm or 13mm GIB Braceline® to one side of the wall only
2. 7mm structural plywood to the other side
3. Corner fastening pattern applies (see p.71)
4. 32mm x 6g GIB® Grabber® screws or GIB® Grabber® Dual Thread screws at 150mm max to perimeter (plasterboard side). 50 x 2.8mm FH nails at 150mm max to plywood perimeter. Corner fastening pattern not applicable (plywood side)
5. Panel hold downs required
6. Centre of the sheet may be fixed with adhesive or fastenings at 300mm max
7. Joints must be stopped
8. GIB® tape must be used in joints
9. Sheets may be fixed horizontally or vertically

Bracing Element – Plasterboard side shown

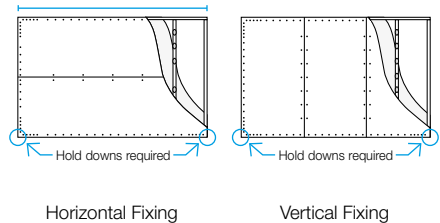

For sheet substitution options refer to p.14.

Scan to view GIB® installation videos



6.1.3 Installation Summary - Exterior System Options

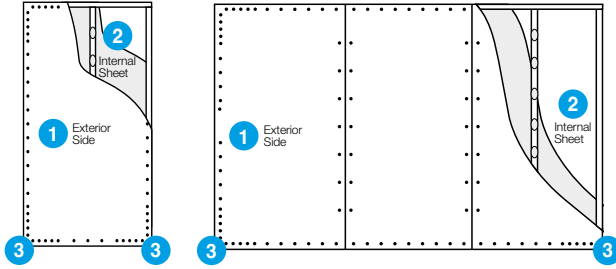

	Exterior Side 1			Internal Sheet 2			Panel Hold-Down Fixings 3
	Lining	Fasteners	Fastener Spacing	Lining	Fasteners	Fastener Spacing	
GSW-N GSW-H	10mm or 13mm GIB Weatherline®	41mm x 6g GIB® Grabber® ceramic coated high thread screws.	<p>Corner screw placement as illustrated on p.71.</p> <p>Screw placement at 150mm max to sheet perimeter.</p> <p>Centre of the sheet fixed at 300mm max.</p>	Any 10mm or 13mm GIB® plasterboard	32mm x 6g GIB® Grabber® high thread screws	<p>Corner screw placement as illustrated on p.71.</p> <p>Screw placement at 150mm max to sheet perimeter.</p> <p>Centre of the sheet may be fixed with adhesive or fastenings at 300mm max.</p>	<p>Not Required</p> <p>Yes</p>
W-H				Not Required			Yes
BLW-H				10mm or 13mm GIB Braceline®/ Noiseline®	32mm x 6g GIB® Grabber® high thread screws	<p>Corner screw placement as illustrated on p.71.</p> <p>Screw placement at 150mm max to sheet perimeter.</p> <p>Centre of the sheet may be fixed with adhesive or fastenings at 300mm max.</p>	Yes

Note: Minimum bracing element length is 400mm

GSW-N

- Corner fastening pattern applies (see p.71)
- Panel hold downs not required

Exterior Side

1. 10mm or 13mm GIB Weatherline® to exterior side of the wall
2. Fasteners 41mm x 6g GIB® Grabber® ceramic coated high thread screws
3. Refer to wind loading section for the GIB Weatherline® Design and Construction Manual for fastener centres
4. All joints and screw fixing must be taped with GIB Weatherline® Flashing Tape, no plaster stopping is required

- Corner fastening pattern applies (see p.71)
- Panel hold downs not required

Internal Side

1. Any 10mm or 13mm GIB® plasterboard to one side of the wall only
2. Corner fastening pattern applies (see p.71)
3. 32mm x 6g GIB® Grabber® screws or GIB® Grabber® Dual Thread screws at 150mm max to perimeter
4. Centre of the sheet may be fixed with adhesive or fastenings at 300mm max
5. Panel hold downs not required
6. Joints must be stopped
7. GIB® tape must be used in joints
8. Sheets may be fixed horizontally or vertically

Bracing Element – Internal side

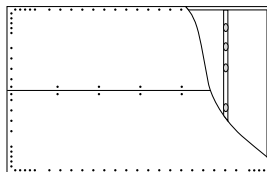

Horizontal Fixing

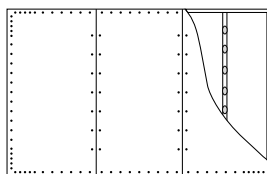

Vertical Fixing

GSW-H

- Corner fastening pattern applies (see p.71)
- Panel hold downs required

Exterior Side

1. 10mm or 13mm GIB Weatherline® to exterior side of the wall
2. Fasteners 41mm x 6g GIB® Grabber® Ceramic Coated High Thread Screws
3. Refer to wind loading section for the GIB Weatherline® Design and Construction Manual for fastener centres
4. All joints and screw fixings must be taped with GIB Weatherline® Flashing Tape, no plaster stopping is required

Internal Side

1. 10mm or 13mm GIB Braceline® to one side of the wall only
2. Corner fastening pattern applies (see p.71)
3. 32mm x 6g GIB® Grabber® screws or GIB® Grabber® Dual Thread screws at 150mm max to perimeter
4. Centre of the sheet may be fixed with adhesive or fastenings at 300mm max
5. Panel hold downs required
6. Joints must be stopped
7. GIB® tape must be used in joints
8. Sheets may be fixed horizontally or vertically

Bracing Element – Interior side

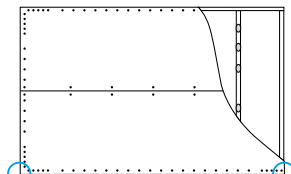

Horizontal Fixing

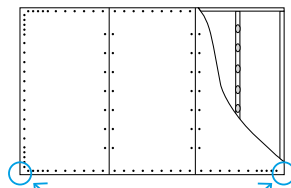

Vertical Fixing

For sheet substitution options refer to p.14.

6.1.4 Exterior Bracing Systems Specifications

W-H

- Corner fastening pattern applies (see p.71)
- Panel hold downs required

Exterior Side

1. 10mm or 13mm GIB Weatherline® to exterior side of the wall
2. Fasteners 41mm x 6g GIB® Grabber® Ceramic Coated High Thread Screws
3. Screw placement at 150mm max to sheet perimeter
4. Centre of the sheet fixed at 300mm max
5. All joints and screw fixings must be taped with GIB Weatherline® Flashing Tape, no plaster stopping is required

Bracing Element – Exterior side

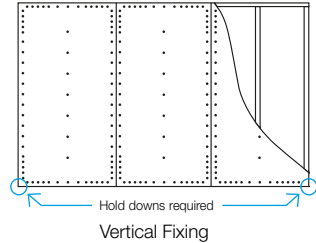

BLW-H

- Corner fastening pattern applies (see p.71)
- Panel hold downs required

Exterior Side

1. 10mm or 13mm GIB Weatherline® to exterior side of the wall
2. Fasteners 41mm x 6g GIB® Grabber® Ceramic Coated High Thread Screws
3. Refer to wind loading section for the GIB Weatherline® Design and Construction Manual for fastener centres
4. All joints and screw fixings must be taped with GIB Weatherline® Flashing Tape, no plaster stopping is required

Internal Side

1. Any 10mm or 13mm GIB® plasterboard to one side of the wall only
2. Corner fastening pattern applies (see p.71)
3. 32mm x 6g GIB® Grabber® screws or GIB® Grabber® Dual Thread screws at 150mm max to perimeter
4. Centre of the sheet may be fixed with adhesive or fastenings at 300mm max
5. Panel hold downs not required
6. Joints must be stopped
7. GIB® tape must be used in joints
8. Sheets may be fixed horizontally or vertically

Bracing Element – Interior side

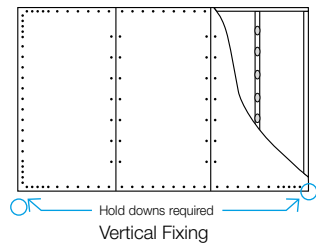
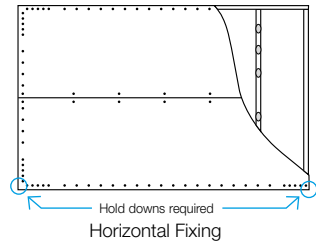

For sheet substitution options refer to p.14.

Scan to view GIB® installation videos



6.1.5 Bottom Plate Fixing

Bottom Plate Fixings for GIB® Bracing Elements

Brace Type	Concrete Slabs		Timber Floors
	External Walls	Internal Walls	External and Internal Walls
GS1-N GSW-N	As per NZS 3604:2011 No specific additional fastening required	As per NZS 3604:2011 Alternatively use 75 x 3.8mm shot-fired fasteners with 16mm discs, 150mm and 300mm from each end of the bracing element and at 600mm thereafter.	Pairs of 100 x 3.75mm flat head hand driven nails or 3/90 x 3.15mm power driven nails at 600mm centres in accordance with NZS 3604:2011
GS2-N GS2-NOM	Not applicable		
GSP-H BL1-H BLP-H GSW-H W-H BLW-H	Intermediate fastenings to comply with NZS 3604:2011 In addition: GIB HandiBrac® fixings or metal wrap-around strap fixings and bolt as illustrated on p.69-70		Pairs of 100 x 3.75mm flat head hand driven nails or 3/90 x 3.15mm power driven nails at 600mm centres in accordance with NZS 3604:2011 In addition: GIB HandiBrac® fixings or metal wrap-around strap fixings and bolt as illustrated below
BLG-H	Not applicable	As for GSP-H, BL1-H, BLP-H on concrete slab as illustrated on p.69-70	

6.1.6 Panel Hold-Down Details

GIB HandiBrac® – Recommended Method

Developed in conjunction with MiTek™ NZ, the GIB HandiBrac® has been designed and tested for use as a hold-down in GIB® BL and GSP bracing elements.

- The GIB HandiBrac® registered design provides for quick and easy installation
- The GIB HandiBrac® provides a flush surface for the wall linings because it is fitted inside the framing. There is no need to check into the framing as recommended with conventional straps
- The GIB HandiBrac® is suitable for both new and retrofit construction
- The design also allows for installation and inspection at any stage prior to fitting internal linings

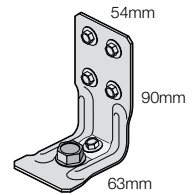

Concrete Floors		Timber Floors	
External Walls	Internal Walls	External Walls	Internal Walls
<p>Position GIB HandiBrac® as close as practicable to the internal edge of the bottom plate</p>	<p>Position GIB HandiBrac® at the stud / plate junction</p>	<p>Position GIB HandiBrac® in the centre of the perimeter boundary joist</p>	<p>Position GIB HandiBrac® in the centre of floor joist or full depth solid block</p>

Hold-Down Fastener Requirements

A mechanical fastening with a minimum characteristic uplift capacity of 15kN or use supplied BT 10/140 screw bolt in GIB HandiBrac® pack.

12 x 150mm galvanised coach screw or use supplied BT 10/140 screw bolt in GIB HandiBrac® pack.

Bracing Strap Installation

Care needs to be taken with the installation of the bracing strap. It should be checked in to be flush with the face of the stud providing a flat substrate for the plasterboard. It should be positioned in such a way that the important corner fastenings of the bracing element are not affected by it. Keeping the strap to the edge of the end stud as shown will allow the important corner fastenings to be installed without having to penetrate the bracing strap.

Concrete Floors

Timber Floors

400 x 25 x 0.9mm galvanised strap to pass under the plate and up the other side of the stud. Six 30 x 2.5 flat head galvanised nails to each side of the stud. Three 30 x 2.5 flat head galvanised nails to each side of the plate. Hold down bolt with 50 x 50 x 3mm washer to be fitted within 80mm of the edge of the element.

Internal Walls	External Walls	Internal Walls	External Walls
			<p>2/300 x 25 x 0.9mm galvanised straps with six 30 x 2.5mm flat head galvanised nails to each stud and into the floor joist and three nails to the plate. Block to nog fixed with 3/100 x 3.75mm nails to stud.</p>

Hold-Down Fastener Requirements

Concrete Floors

A mechanical fastening with a minimum characteristic uplift capacity of 15kN fitted with a 50 x 50 x 3mm square washer within 80mm of the ends of the bracing element.

Timber Floors

12 x 150mm galvanised coach screw fitted with a 50 x 50 x 3mm square washer within 80mm of the ends of the bracing element.

Scan to view GIB® installation videos



6.1.7 GIB EzyBrace® Corner Fastener Pattern

Corner Fastener Pattern for ALL 4 CORNERS OF GIB® Bracing Elements (excluding GS2-NOM).

- All four corners of a GIB® plasterboard bracing element must be fastened as per the fastening patterns shown below

- Bracing element perimeter is then fastened at 150mm centres, or for GS2-NOM 300mm centres
- Fasteners must be no closer than 12mm from the paper enclosed edge and no closer than 18mm from sheet ends or cut edges of sheets

GIB EzyBrace® Corner Fastener Pattern

Unless specified all fastener spacings are maximums.

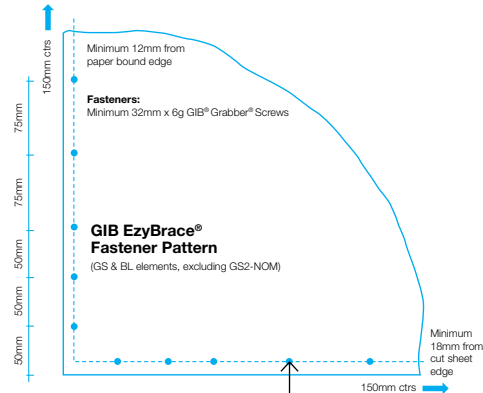

Note: For panels between 400mm and 450mm place this fastener centrally

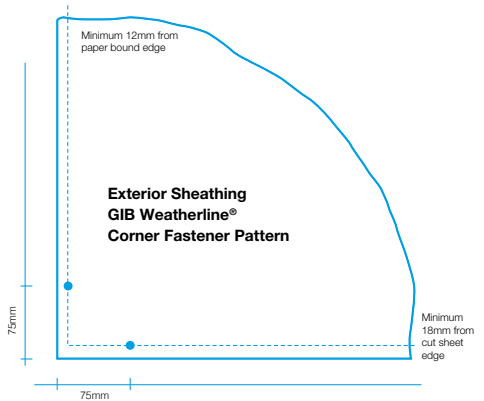

Refer to wind loading section of the GIB Weatherline® Design and Construction Manual for fastening centres, except when installing a W-H bracing element where the GIB EzyBrace® fastener pattern will apply.

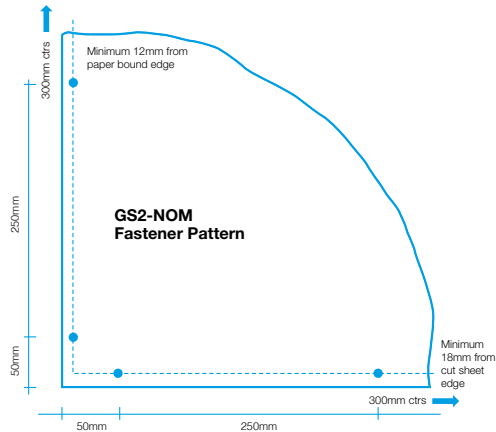

6.1.8 General Installation Details

- Timber framing to comply with NZS 3604:2011
- Minimum stud dimensions:
 - External walls – 90 x 35mm
 - Internal walls – 70 x 45mm
- Use full sheets where possible
- If part sheets are required a min dimension of 300mm applies for all bracing elements
- All joints and fastener heads in GIB EzyBrace® Systems must be stopped. GIB® tape must be used in joints

Bracing in Wet Areas

GIB EzyBrace® Systems are not to be installed inside shower cubicles or around baths.

Outside of these areas it is acceptable to use GIB EzyBrace® Systems in bathrooms and other wet areas provided that the surface of the element is maintained impervious for the life of the building.

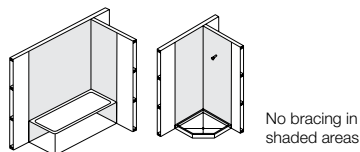

Small Openings in Bracing Elements

Small openings (e.g. power outlets) of 90 x 90mm maximum or circular holes no more than 100mm may be placed no closer than 90mm to the edge of the braced element. A block may need to be provided alongside the perimeter stud as shown below.

When more than 1 small opening is required to be placed in a bracing element, contact the GIB® Helpline for further guidance.

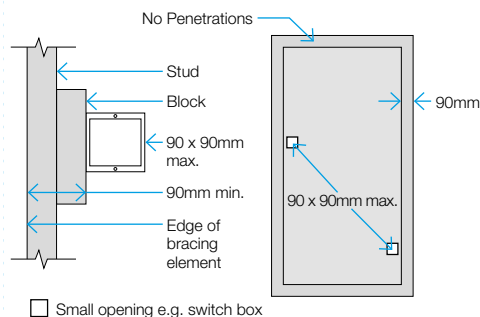

Large Openings in Bracing Elements

For openings above 90 x 90mm such as switch boards, recessed cabinets and TV's etc. should be placed outside of the bracing element or locate the bracing element on the other side of the wall framing.

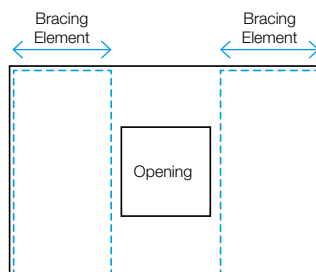

Intersecting Walls

GIB® Bracing Elements may have intersecting walls with a min length of 200mm. Fasteners are required around the perimeter of the bracing element. Vertical joints at T-junctions must be fixed and jointed as specified for intermediate sheet joints. The bracing element length must be no less than 900mm.

Where a Wall Bracing Element is interrupted by a T-junction the element is deemed to be continuous for the whole length (900mm min in the example illustrated).

When fixing part sheets of GIB® plasterboard to the side of a T-junction, a min width of 300mm applies for bracing elements. See figures on p.73.

6.1.8 General Installation Details

Intersecting Walls

Conventional wall layout

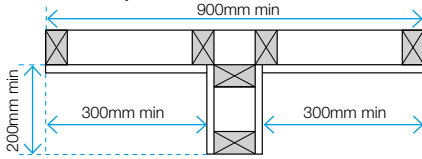

GIBFix® framing alternative wall layout option

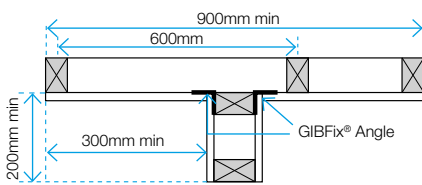

Place nogs at 800mm centres to support GIBFix® Angles.
For more information on the GIBFix® framing system refer to the applicable technical literature at gib.co.nz

Example using fastener pattern for GS and BL elements

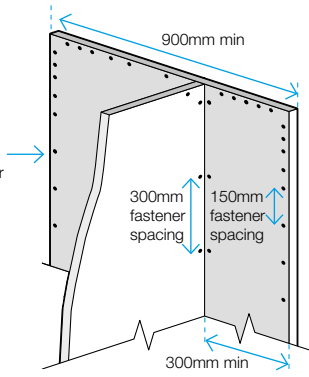

Junction
Minimum 32mm x 6g GIB® Grabber® High Thread or 32mm x 7g GIB® Grabber® Dual Thread Screws at 300mm centres each side

Top Plate Connections

For top plate connection refer to NZS3604:2011 section 8.7.3.

Parapets and Gable End Walls

Bracing elements must be fixed from top plate to bottom plate. Fixing to a row of nogs is not acceptable unless either:

A continuous member such as an 90 x 45mm ribbon plate is fixed across the studs just above a row of nogs at the ceiling line;

OR

GIBFix® Angle is installed as shown. The angle is fixed to a row of nogs with 30 x 2.5mm galvanised flat head nails at 300mm centres.

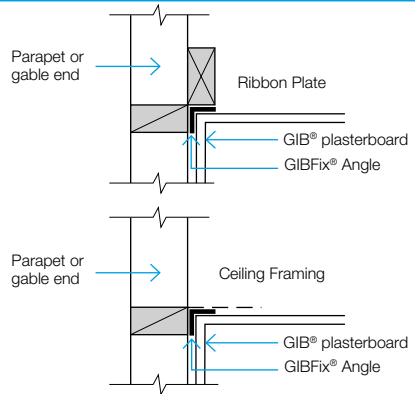

Screw and Adhesive Fix for Openings - GS2-NOM Only

— GIBFix® All-Bond Adhesive

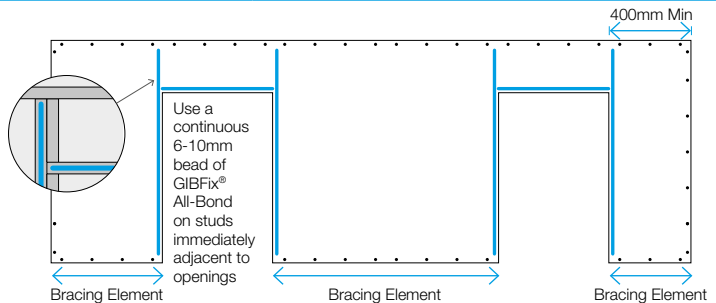

6.1.9 Ceiling Diaphragms

Ceiling diaphragms do not have a bracing unit rating but are used when bracing lines are spaced further than 6.0m apart.

Any 10mm or 13mm GIB® plasterboard can be used for ceiling diaphragms.

Ceiling Diaphragms

Small Openings

Small opening (e.g. down lights) of 90 x 90mm or less may be placed no closer than 90mm to the edge of the ceiling diaphragm.

Large Openings

Openings are allowed within the middle third of the diaphragms length and width. Fixing of sheet material to opening trimmers should be at 150mm centres. Neither opening dimension should exceed a third of the diaphragm width. Larger openings or openings in other locations require specific engineering design.

Flue and Range Hood Openings

Where flue or range hood openings are required in a ceiling diaphragm the use of a galvanised metal backing plate is recommended, with a max hole diameter of 350mm.

Note: Backing plate detail can be used for range hood openings in walls.

For more information refer to the GIB Ezybrace® technical manual.

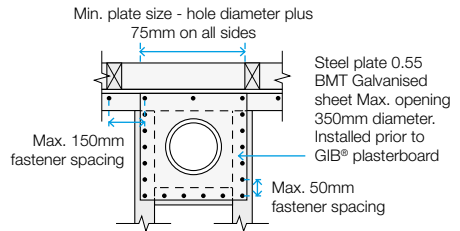
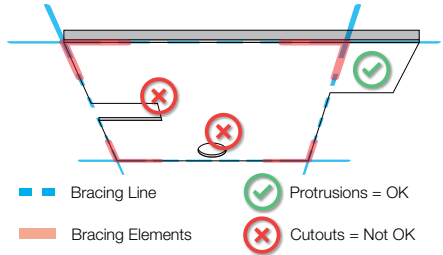

Plasterboard ceiling not shown in plan view

Use full width sheets where possible.

Minimum length sheet – 1.8m

Minimum width sheet – 900mm

Sheets less than 900mm in width but no less than 600mm may be used provided that the sheet edge joint is fully back blocked.

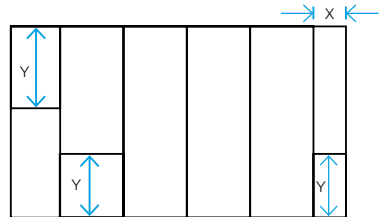

X = 900mm min or 600-900mm min provided all adjacent joints are back-blocked

Y = 1800mm min sheet lengths at ends of ceiling diaphragms

Ceiling diaphragms may be constructed using any GIB® plasterboard provided perimeter fixing is at;

150mm centres for: Diaphragms up to 7.5m in length, no steeper than 15°.

100mm centres for: Diaphragms up to 7.5m in length, no steeper than 45°. Diaphragms up to 12m in length, no steeper than 25°.

Diaphragms outside these parameters must be specifically designed.

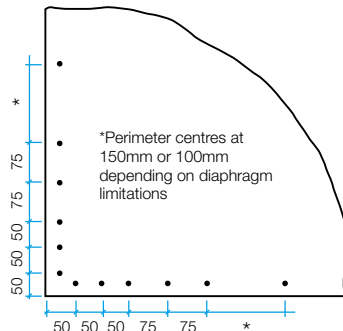

All fastener spacings are maximums

Ceiling Diaphragms

GIB® Rondo® 310 metal ceiling battens may be used if fixed directly through the flanges into the ceiling framing using 2/32mm x 8g wafer head screws.

If the 310 ceiling battens are required to be clip fixed, a block or continuous timber member must be securely attached to the ceiling framing at the level of the back of the metal batten. The batten is then fastened to this timber as shown.

Block or continuous timber member min 300mm fixed with min 4 x 100mm x 3,75mm nails

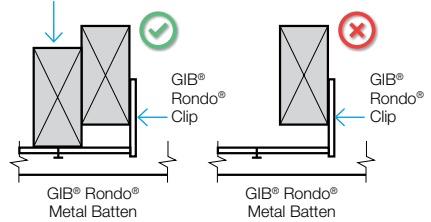

For steel battens a continuous channel or angle is required to the perimeter of the diaphragm.

This must be fastened to the framing with GIB® Grabber® 32mm x 8g wafer head screws at 300mm centres.

Battens must be fixed to the channel with 32mm x 8g GIB® Grabber® wafer head screws.

It is important that a positive connection is created between the top plate and the ceiling substrate.

Covered ceiling diaphragms can be achieved by attaching a folded metal angle to the junctions.

- Minimum .55mm BMT with 100mm each leg
- Fastened at 300mm centres on each edge using 32mm x 6g GIB® wafer head screws

Linings must be fixed to both sides of the metal angle at 150mm or 100mm centres with minimum 25mm x 6g GIB® Grabber® self-tapping screws

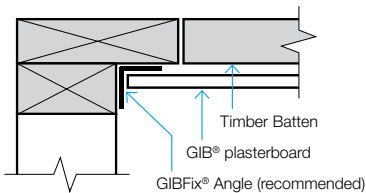
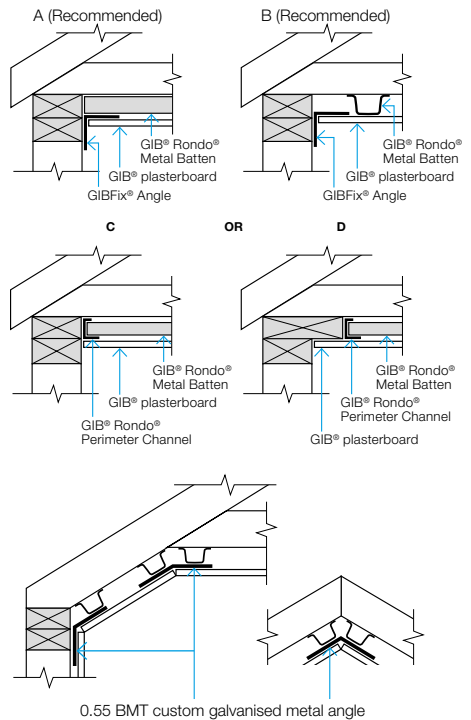

General installation

- Sheet end butt joints must be formed off framing and back-blocked (see p.50)
- Framing and ceiling batten requirements for ceiling diaphragms are the same as for general ceiling installation (see p.48)
- The body of the ceiling must be fixed as per general ceiling installation (see p.48)

- Openings and penetrations in ceiling diaphragms are as for wall bracing (see p.74)
- Linings must be installed over the entire area of the diaphragm
- Joints and fastener heads must be stopped. GIB® tape must be used in joints

6.2 GIB AQUALINE® WET AREA SYSTEMS

This section covers the installation of GIB Aqualine® Wet Area Systems. Full information can be found in the GIB Aqualine® Wet Area Systems literature.

GIB Aqualine®

GIB Aqualine®, with its green face paper, has a water resistant core which will provide resistance to the effects of moisture in wet areas such as bathrooms and laundries.

Although able to cope with infrequent short-term exposure, standard gypsum plasterboard will have a shortened life expectancy when frequently exposed to water or moisture.

The NZBC does not call for water resistant linings in wet areas but it is highly desirable to incorporate lining materials which will maintain their integrity longer when exposed more frequently to water or steam and particularly to one-off events such as leakages or flooding of a room.

Limitations

- Do not use GIB Aqualine® in situations where it is exposed for extended periods to humidities of 90% RH or greater. Such areas include group shower rooms, as well as moisture and chlorine laden environments such as indoor heated swimming pools
- GIB Aqualine® must not be installed in exterior situations
- GIB Aqualine® must not be directly applied to solid plaster (gypsum or cement) wood based sheet linings or similar materials, masonry or concrete. GIB Aqualine® may only be applied to these materials where timber strapping or steel furring channels are installed
- GIB Aqualine® must not be installed over a vapour barrier or a wall acting as a vapour barrier
- GIB Aqualine® must not be used for bracing purposes in shower cubicles or over baths

NZBC Clauses E3 Internal Moisture

E3.3.4 requires impervious and easily cleaned surfaces to all surfaces adjacent to sanitary fixtures or laundering facilities.

E3.3.5 requires that surfaces of building elements likely to be splashed or contaminated in the course of the intended use of the building, must also be impervious and easily cleaned.

E3.3.6 requires that surfaces of building elements likely to be splashed must be constructed in a way that prevents water from penetrating behind linings or into concealed spaces (e.g. wall cavities).

Walls in wet areas therefore need to be addressed according to whether they fall within the scope of one of the following descriptions:

1. Wall surface likely to be splashed
2. Wall surfaces directly exposed to water e.g. shower walls

Although not a requirement of NZBC it is highly recommended that the wall surfaces within 150mm of the top edge of a bath, and the vertical faces immediately under the edge of a bath, are treated in the same way as for a shower wall.

Alternative GIB® Plasterboard Options

For a list of permitted plasterboard substitution options for GIB Aqualine® refer to p14.

Scan to view GIB® installation videos



6.2.1 Surface in Showers and Around Baths

A waterproof membrane complying with AS/NZS 4858 MUST be applied to all lining materials used under ceramic tiles in these areas.

The waterproof membrane must extend to a 1500mm horizontal radius from a shower rose unless the shower is contained within a fixed enclosure. A shower curtain does not constitute a fixed enclosure.

Particleboard flooring manufacturers recommend that in wet areas, panels should be protected with a suitable wet area membrane or an integrally waterproof sheet material. Some local authorities call for this treatment on all timber based floors. Local requirements should be checked before proceeding.

Enclosed shower over bath

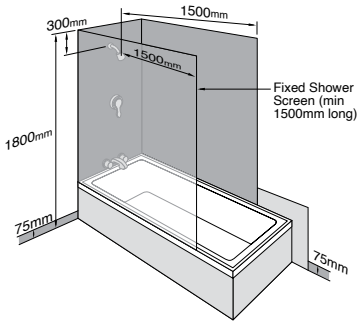

Unenclosed shower over bath

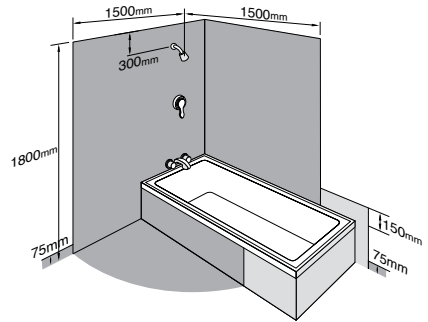

Enclosed Shower

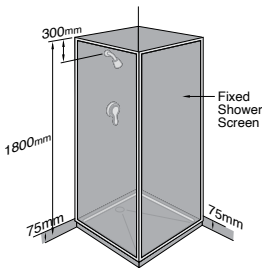

Unenclosed shower

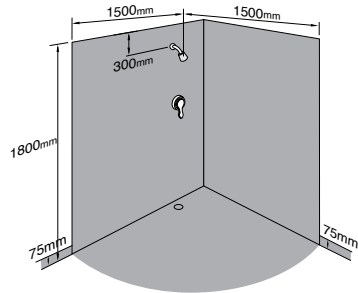

Bath

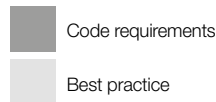
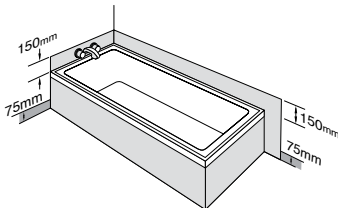

6.2.2 Fixing Details for Non Tiled Walls

As for general installation details (see p.41-44)

Ceilings

Fixing as for GIB® Standard plasterboard (see p.48)

6.2.3 Fixing Details for Tiled Walls

Wall Framing

Timber Framing dimensions and spacings must comply with the requirements of NZS 3604:2011.

Prior to lining in tiled areas (shower cubicles and shower over bath only) the internal corners should be reinforced with a minimum 32mm x 32mm angle such as NZ18 or GIBFix® Angle. Each side of the angle should be fastened to the framing with 30mm galvanised clouts at 300mm max centres (see p.80).

Steel stud systems are proprietary but do not generally incorporate nogs except as required below:

- Adjacent to each pipe penetration and behind sink and tub flashings
- Between all studs above bath flanges and preformed shower bases
- To support towel rails, grab rails and wall basin brackets
- For impact protection in shower cubicles or shower over bath situations it is important that all sheet joints are made on solid blocking. This may either require vertical fixing of the GIB Aqualine® or the installation of some additional nogs

Maximum Tile Weights for GIB Aqualine®, GIB Toughline® Aqua or GIB Weatherline®

Stud Centre (max)	Fasteners Centre (max)	Lining Thickness	Tile Weight
600mm max	150mm max	10mm	26kg/m ²
		13mm	40kg/m ²

Jointing

All sheet joints must be GIB® tape reinforced and stopped in accordance with instructions on p.91.

Lining and Tile Weights

- For 10mm GIB Aqualine® use min 25mm x 6g GIB® Grabber® Drywall Screws
- For 13mm GIB Aqualine® use min 32mm x 6g GIB® Grabber® Drywall Screws
- GIB Aqualine® may be fixed vertically or horizontally
- Provide a 5mm–10mm gap at the wall/floor junction
- Provide a 5mm–10mm gap between the bottom edge of the GIB Aqualine® and any bath rim or preformed shower base to allow for placement of sealant
- GIB Aqualine® sheets should be touch fitted
- Where the framing or fastener centres required for tiled GIB Aqualine® are closer than those specified for GIB® Fire Rated and GIB Noise Control® Systems, the GIB Aqualine® specification will prevail. Where relevant check fastener lengths comply with requirements of GIB® Fire Rated Systems
- Do not fix tiles to GIB® plasterboard ceilings or non-vertical planes

Jointing

- Jointing must be carried out in accordance with instructions on p.93
- No joint compound is required under impervious shower linings
- Air drying compounds shall not be used on areas that are to be tiled

Scan to view GIB® installation videos



Horizontal Fixing

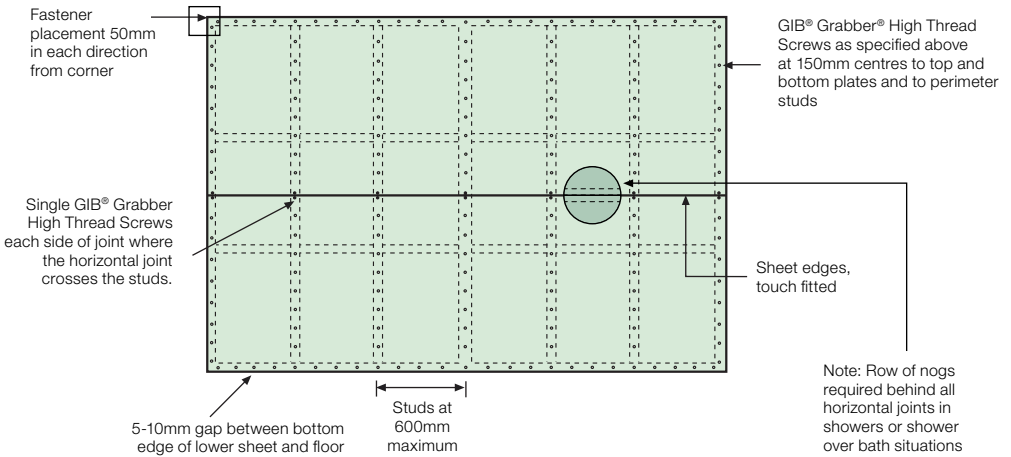

Vertical Fixing

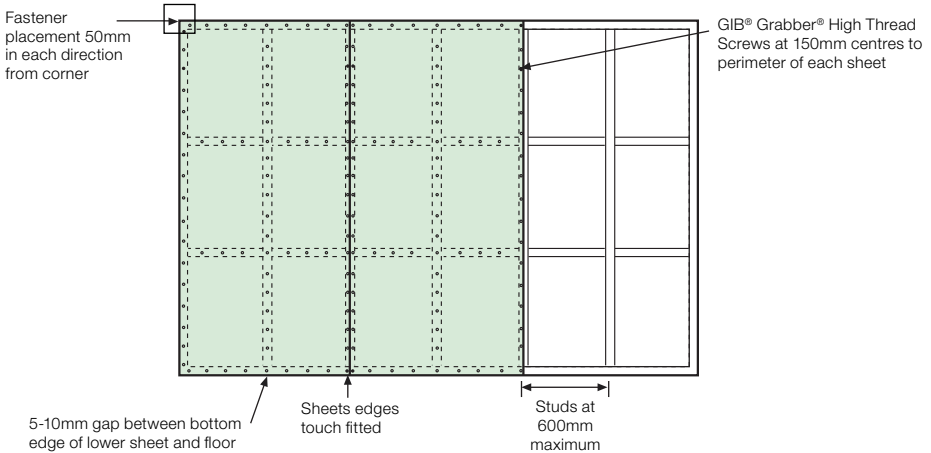

6.2.4 Metal Angles for Tiled Internal Corners

- Prior to lining in tiled areas (shower cubicles and shower over bath only) the internal corners shall be reinforced with a minimum 32 x 32 x 0.55mm galvanised metal angle
- Suitable GIB® metal angle options include:
 - GIB® Rondo® NZ18 metal angle, available length: 3.0m

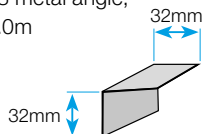

- GIBFix® Angle metal angle, available lengths: 2.4m and 2.7m

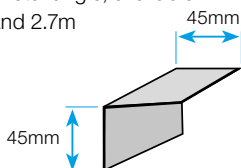

- Angles need to be temporarily held in place until secured by the lining fixings
- Minimum height of the metal angle is 1800mm

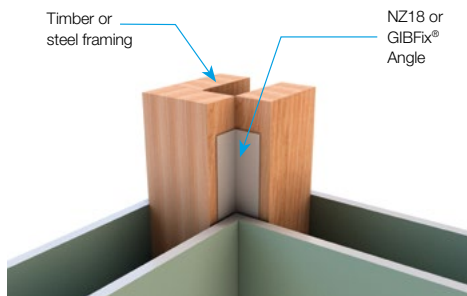

Waterproof Membrane Systems

A waterproof membrane system must be applied to all lining materials used as a substrate for ceramic tiles in a shower or shower over a bath

application, or any other tiled application exposed to frequent water splash.

Tiles and Tile Weights

In areas likely to be directly exposed to water, tiles may be ceramic, porcelain or stone must comply with the over-surface finish requirements of the IWAM Code of Practice and be bedded with a suitable tile adhesive on the waterproof membrane system. See page 77 for the minimum extent of wall surfaces requiring impervious sheet materials or waterproof membrane systems prior to tiling.

Smaller mosaic tiles are often lighter, but the integrity of grout joints might be more prone to impact, whilst heavier tiles are larger and have less and deeper grout and sealant joints. For more information also see AS 3958:2007 Ceramic tiles – Guide to the installation of ceramic tiles.

Adhesive and Grout Weights

The weight of adhesive and grout can vary depending on the type of tile and the installation process used. The maximum tile weights stated in the table opposite are conservative and refer to the tile weight excluding grout and adhesive used. An additional 3kg/m² has been factored into tile adhesion testing on top of the above stated tile weights to account for adhesive and grout weight used during the installation of the tile.

Maximum Tile Weights for GIB Aqualine®, GIB Toughline® Aqua or GIB Weatherline®

Stud Centre (max)	Fasteners Centre (max)	Lining Thickness	Tile Weight
600mm max	150mm max	10mm	26kg/m ²
		13mm	40kg/m ²

6.2.5 Tiling, Flexible Sheet Vinyl and Rigid Sheet Shower Linings

Tiling

- Tile grouting and sealing must be carried out in accordance with the requirements of AS3958.1 2007 (Guide to the Installation of Ceramic Tiles)
- Provide for surface control joints at 4m centres maximum
- The adhesive must be organic based complying with AS2358 – 1990 (Adhesives for Fixing Ceramic Tiles)
- Note that the adhesive should be combed in a horizontal direction only. It is important that adhesive is applied to the wall and not “buttered” onto individual tiles

Flexible Sheet Vinyl – Showers and Other Wet Areas

- GIB Aqualine® is a suitable substrate for flexible vinyl wall finishes in wet areas of residential, commercial or institutional buildings
- Framing requirements and installation procedures for the GIB Aqualine® substrate must be as per p.78, except that the lining gap at the floor is reduced to 5mm when a pencil cove detail is used
- The installation of metal reinforcing angles (minimum. 32 x 32 x 0.55mm) behind internal GIB Aqualine® corners is recommended for sheet vinyl applications in showers or shower over bath situations (see illustration p.82)
- The GIB Aqualine® lining must be jointed and stopped to a paint quality finish (Level 4) – trowel marks can telegraph through even a commercial grade 2mm vinyl
- A minimum vinyl thickness of 2mm is recommended for the wall finish in commercial or institutional bathrooms and showers
- In areas directly exposed to liquid water, all joints in flexible sheet vinyl must be heat welded
- Installation of the flexible vinyl must be carried out strictly in accordance with the specifications provided by the suppliers/manufacturers of the vinyl

Rigid Sheet Shower Linings

- The manufacturers/suppliers of thin (usually 2mm–3mm) and rigid acrylic shower linings commonly recommend direct adhesive fixing to wall linings using solvent-based adhesives
- Do not pre-seal areas which are to be covered by the rigid shower linings
- Some suppliers of rigid sheet acrylic shower linings recommend a minimum of one week for the adhesive to cure fully prior to use
- Water temperature changes will cause movement of the thin acrylic sheet, which in turn will stress the adhesive and wall lining substrate
- Care must be taken to ensure that rooms are adequately ventilated and the adhesive is fully cured before the shower is used
- Consult the manufacturer/supplier of the shower lining for full installation details

Waterproof Membranes (tiled shower areas and shower over baths)

- In showers and shower over bath situations the GIB Aqualine® system is not complete and ready for tiling until coated with a waterproof membrane over the lining and the jointed areas
- Only in-situ waterproofing materials which are manufactured to AS/NZS 4858:2004 Wet Area Membranes Requirements are recommended.
- Waterproof membranes must be fully cured and dry prior to application of tiling adhesives
- Embed reinforcing mats in the membrane at all internal corners of the shower (including floor/wall junctions)

For further information on waterproof membranes prior to tiling, consult BRANZ GOOD PRACTICE GUIDE TILING.

FIG. B: Typical Details for Tiled Shower over Bath

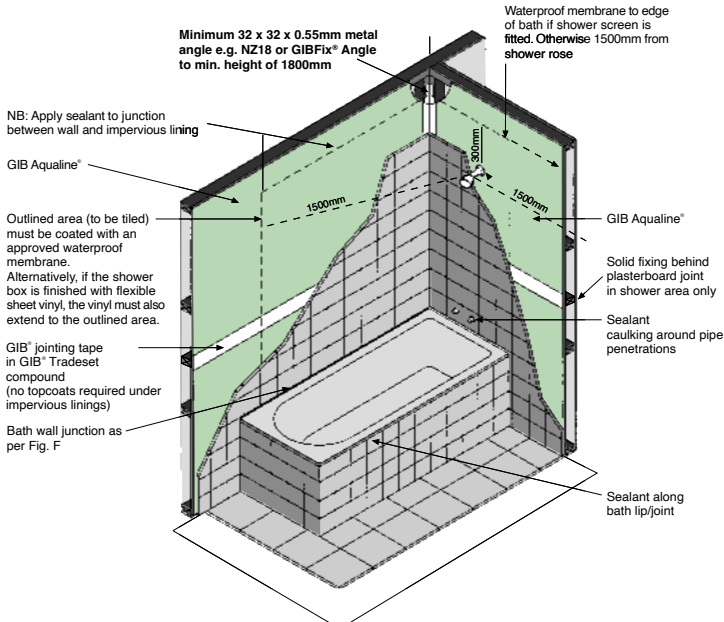

FIG. C: Typical Details for Tiled Shower Enclosure

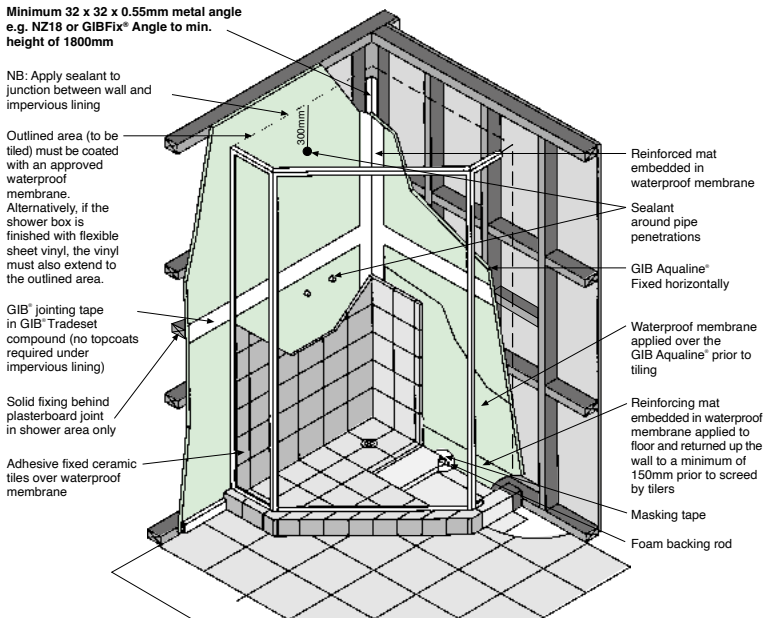

FIG. D: Typical shower edge detail

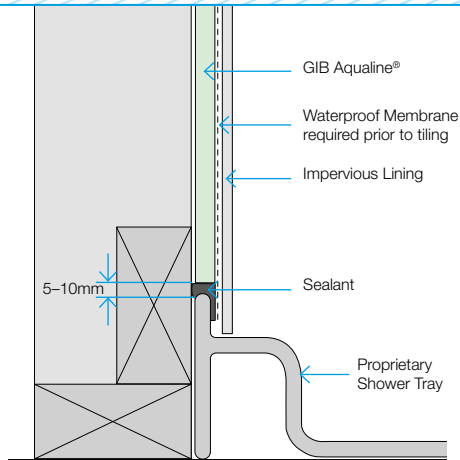

FIG. E: Typical shower edge detail in fire or noise control area

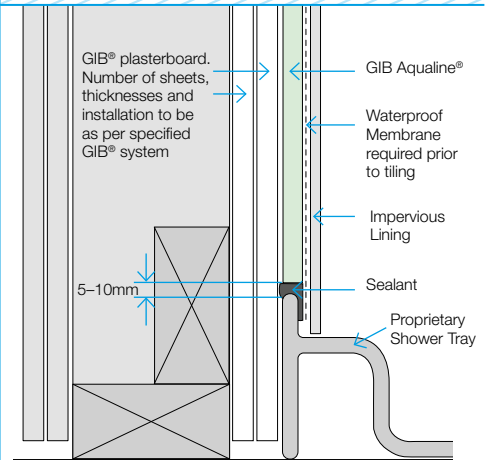

FIG. F: Typical bath edge detail

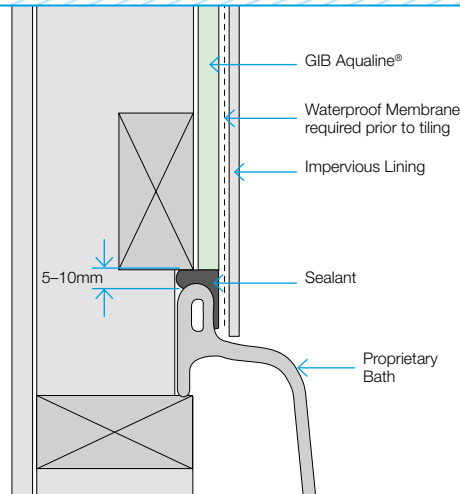
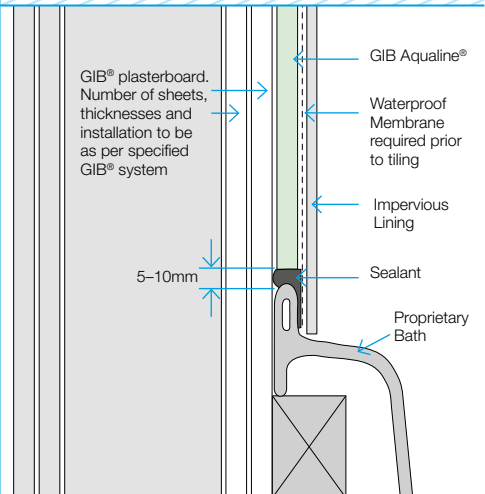

FIG. G: Typical bath edge detail in fire or noise control area



As the edge profiles of showers and baths can vary significantly between manufacturers, these details are intended only as a guide. Attention should be paid to ensure that:

- Sufficient sealant to effect a waterproof barrier has been used
- The sealant has been applied in a manner that does not permit water ingress

Note: The gap between the front face of the shower/bath upstand and the front face of the GIB Aqualine® should be 1mm–4mm. This may require additional packing behind final layer of GIB Aqualine® OR checking shower tray or bath into framing.

Silicone sealants must be of the mould inhibiting type and must be compatible with GIB Aqualine®, shower/bath surfaces and the impervious lining.

6.2.6 Typical Construction Details

It is recommended that GIB Aqualine® is fixed to ceilings in wet areas such as bathrooms and

laundries. Installation is the same as for standard ceiling. See p.48.

FIG. H: Typical Plumbing Penetration

Penetrations in wet areas should be sealed with silicon sealant to prevent moisture access to the framing.

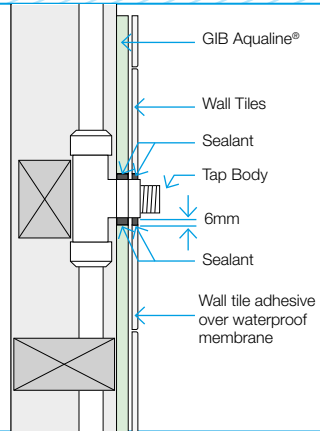

FIG. I: Sealing Under Mixer Facia

Apply a bead of sealant behind the cover plate on shower mixer to divert any water from the penetration.

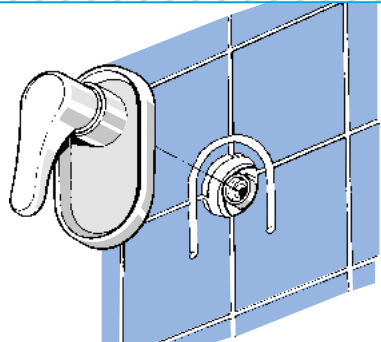

FIG. J: Tiled Shower – Internal Corner Detail

Edge profiles of baths and shower trays can vary significantly between manufacturers. Always follow the manufacturers installation instructions.

The details shown are intended as a guide only.

Allow 5mm–10mm gap between bath rim and/or shower base to allow for installation of sealant.

Sealants should contain a mould inhibitor.

Ensure that the gap is well filled with sealant.

Minimum 32 x 32 x 0.55mm metal angle e.g. NZ18 or GIBFix® Angle to min. height of 1800mm

GIB Aqualine®

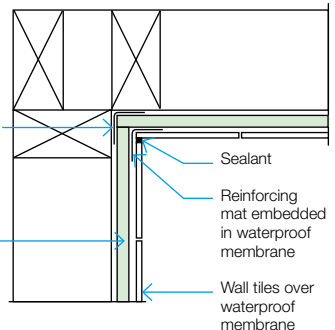

6.3 GIB® FIRE, NOISE AND OTHER PERFORMANCE SYSTEMS

Because of the volume of information it is not feasible to include installation guidance for all the GIB® Performance Systems in the GIB® Site Guide. If you are installing GIB® Performance Systems including GIB® Fire, Noise, Tough, Rigid Air Barrier or Intertenancy Barrier systems it is strongly recommended that you obtain a copy of the relevant specification and installation publication prior to commencing installation.

These can be easily accessed by:

- Download from gib.co.nz
- Download the GIB® App available free from the App or Google Play Stores
- Contact the GIB® Helpline on 0800 100 442
- Or from most GIB® plasterboard stockists

6.3.1 GIB® Fire Rated Systems

The NZBC requires fire safety systems to reduce the risk of injury or death, and to protect adjacent property in a fire situation.

Fire rated systems require attention to the details in the GIB® Fire Rated Systems literature.

Deviating from these specifications can invalidate the system leading to expensive remedial work to comply or increased risk in case of fire.

A fire system is NOT simply a matter of fixing GIB Fyreline® instead of another GIB® plasterboard.

The fire resistance rating can only be assured when the board has been installed strictly in accordance with the relevant instructions in the GIB® Fire Rated Systems literature.

6.3.2 GIB Noise Control® Systems

Noise control for Intertenancy situations is comprehensively covered in GIB Noise Control® Systems literature. As these situations are generally subject to building code requirements, it is important that the publication is consulted to design and construct Intertenancy noise control systems.

Sound Transmission Class (STC)

STC relates to airborne noise such as speech, TV and so on. It is the ability of a wall, ceiling, or floor/ceiling to reduce noise from rooms next door. In general a higher STC means a better performance.

STC 35 – Normal speech may be clearly heard in the next room

STC 45 – Muffled speech may be heard in the next room

STC 55 – Minimum building code requirement for intertenancy walls

Impact Insulation Class (IIC)

IIC measures the ability of a floor or ceiling system to reduce noise resulting from impacts such as footsteps, falling objects and moving furniture. A higher IIC means a better performance. Impact noises easily travel from hard surfaces into the structure and to the room below. Hard surfaces such as finished timber floors and ceramic tiles often cause noise transmission to the room below. Semi-hard surfaces such as cork tiles and flooring grade vinyl perform a little better, but still do not efficiently absorb impact energy. Installing carpet and underlay is an effective way of reducing impact noise. Installing a GIB Noise Control® System will help reduce impact and airborne noise levels.

Scan to view GIB® installation videos



7.0 JOINTING AND FINISHING SYSTEMS

Jointing and finishing of GIB® plasterboard is to be as per instructions to meet requirements of AS/NZS 2589:2017.

This section covers the basics of joint construction and finishing.

For details on the full GIB® compound and accessory range refer to p.15-24.

Note: The use of correct GIB® materials and practices is critical to delivering adequate joint strength and resistance to cracking which in turn contributes to the performance of GIB® plasterboard bracing systems.

7.1 JOINTING – MATERIALS

GIB® Jointing Tapes

GIB® Paper Tape provides reinforcing and resistance to joint cracking. It is pre-creased for use in internal corners. The rougher side of the tape must face the wall surface when bedded in to the jointing compound.

GIB RocTape® is a fibreglass matt tape suitable for flat joints.

Jointing Compounds.

There are two general types of jointing compound:

Plaster Based (Setting Compounds)

These compounds are powders based on plaster of paris. They have a specific working time before they start to set and harden when mixed with water in the recommended ratio.

Once the set time is reached, the product begins to harden as a result of chemical reaction between the plaster with water.

Plaster based compounds are mixed on site, enabling viscosity to be adjusted as it's mixed so that it's suitable for the chosen application method.

Product examples: GIB Tradeset® range (different set times), GIB LiteSet®, GIB Lite Blue® and GIB MaxSet®. Refer to p.21-24 for details.

Air Drying Compounds

These compounds are pre-mixed pastes and are ready to use direct from their pails. They do not set but rather rely on evaporation of water to enable their polymer binder to cure.

These products are generally formulated to be softer and easier to sand, so are normally used for the third or top coat. Some air drying compounds are designed as multi-purpose so they can be used for all three coats. Please consult p.21-24 before using a three-coat air drying compound system.

GIB® Jointing Tapes



Plaster Based Jointing Compounds



Air Drying Jointing Compounds



Product examples: GIB Trade Finish® range (Heavy Weight, Multi, Lite and Extra Lite), GIB Plus 4® or GIB Redifilla® range.

Refer to p.21-24 for details of each compound's performance.



7.2 DETERMINING HOW MUCH YOU NEED

The table below gives the approximate usage rates for some joint compounds. These figures are approximate and will vary depending on wastage

and the actual thickness at which the product is applied.

APPROXIMATE COVERAGE OF JOINT COMPOUNDS

Coverage in lineal metres per package size

2 coats (taping plus second coat)	
GIB LiteSet®	200m (per 18kg bag)
GIB Tradeset®	200m (per 20kg bag)
GIB MaxSet®	260m (per 20kg bag)
GIB X-Block®	90m (per 25kg bag)
Second coat only	
GIB Lite Blue®	330m (per 17.5kg bag)
Top coat only	
GIB Plus 4®	75m (per 15L pail)
GIB Trade Finish® Heavy	70m (per 15L pail)
GIB Trade Finish® Multi	75m (per 15L pail)
GIB Trade Finish® Lite	75m (per 15L pail)
GIB Trade Finish® Extra Lite	75m (per 15L pail)
All three coats (taping plus two coats)	
GIB Plus 4®	50m (per 15L pail)
GIB Trade Finish® Multi	50m (per 15L pail)
GIB Trade Finish® Lite	50m (per 15L pail)
GIB Trade Finish® Extra Lite	50m (per 15L pail)

*Skim coat at 1mm thick yields approximately 10m² per kg.

Note: These are estimated quantities, and can vary significantly due to site conditions and fixing practices. They are intended as a rough guide and should not be used for quoting purposes.

7.3 WEATHER AND VENTILATION

Weather Conditions

Understanding the part that weather conditions play in joint construction is critical for the creation of trouble free joints.

Cool Weather

In cool weather the rate of drying drops dramatically so achieving a dry coating in a commercially acceptable time becomes an issue. Under these conditions a thick coating of air drying compound also results in longer drying times, so most stoppers use a setting compound for the first and second coats followed by a thin top coat of an air drying compound.

As the overall amount of drying is diminished under cool weather conditions, it is wise to use a harder sanding finishing compound such as GIB Trade Finish® Multi, or GIB Trade Finish® Heavy which will sand with less risk of scratching or “swirling”.

In cold weather, issues such as partial freezing of the mixing water can result in poor feathered edge adhesion. Do not use below the minimum temperature stated on the bag or pail. The biggest issue here is the speed of drying of plaster. If it has not dried before the next coat is applied, it will shrink, and the result can be delayed shrinkage and hollow joints.

To minimise the above issues, the building needs a source of heating. One option is placement of one 2kW fan heater every 50m² of floor area. This will create slight air movement and take the chill off the air, thereby creating conditions more favourable to drying at a reasonable rate. These provide a gentle uniform heating effect. Always check with the main building contractor before doing this. Check the heater has a thermal overload and always remove all possible sources of combustion (bits of paper etc.) before using.

Try to avoid going above 18–20°C in any individual room in the building. Rapid drying through excessive heat can cause popping or movement of fasteners and joints.

Note: It is not a good idea to use air drying compounds for all coats in winter in an unheated building. Shrinkage will result if each coat has not dried properly, and the ability to dry in a reasonable time is significantly diminished in this situation.

Hot Weather

This may be defined as ‘any part of the job and/or the air around the area of stopping with a temperature at, or above, 25°C’.

In these conditions we recommend the use of GIB Tradeset® 90 or shorter set products such as GIB Tradeset® 45. Air drying compounds tend to be good in hot weather and dry out reasonably quickly.

Rooms that heat up to this extent during the morning should be taped in early so that the compound has a chance to fully set.

Digital thermometers are readily available at hardware stores, to accurately measure surface and air temperatures on site for more informed decision making.

Ventilation and Air Drying

Winstone Wallboards recommends:

- At least one window be opened at either end of the building. Even in wet weather this will allow airchanges and some drying throughout the building. The exception to this would be fog and continual rain. In colder weather these air changes are even more critical as the air carries less moisture
- If the building is locked shut with no air movement the air will dry the joints until such time it has reached 100% humidity and then the drying process will stop

Examples of Relative Humidity (RH) in New Zealand Homes

Averages			
Average ambient humidity (approx.)		=	70% RH
At 70% RH the moisture air can carry		=	30% moisture
Air temp	RH		Moisture air can carry
10°C	70%	=	2.7g /m ³
20°C	70%	=	5.1g /m ³
Typical house example			
Floor Area		=	190m ²
Cubic volume		=	450m ³ (approx.)
Plaster used on house (approx.)		=	100kg
Water required to mix plaster (approx.)		=	66ltrs
Water naturally retained in plaster (approx.)		=	10ltrs
Water to be evaporated from plaster (approx.)		=	56ltrs
Example #1 – House temp 10C and RH 70%			
House volume multiplied by 450m ³ x 2.7g/m ³		=	1.21kg
Moisture the air can carry		=	At 10°C/ 70% RH the maximum moisture the air inside this house can hold is 1.21kg
Example #2 – House temp 20C and RH 70%			
House volume multiplied by 450m ³ x 5.1g/m ³		=	2.30kg
Moisture the air can carry		=	At 20°C/ 70% RH the maximum moisture the air inside this house can hold is 2.30kg
Conclusion			
At 20°C / 70%RH it will take 24 complete air changes to remove the 56ltrs of moisture in this house. However at 10°C / 70%RH it will take even longer requiring 46 complete air changes.			

Setting Compounds

Plaster based compounds are generally used for the base and the second coats of a plasterboard jointing system.

When the setting compound is mixed with water it forms a paste which can be trowelled to form smooth flat joints and which subsequently sets hard.

Plaster requires a specific amount of water to fully set. In hot weather the mixed compound can dry and the water content can drop below this amount before it starts to set. The longer the compound's set time, the more likely it can dry too much before it sets. When dry, the end result can be a "soft" or "weak" bedding compound, poor tape adhesion and poor resistance to cracking.

Air Drying

To provide better plasterboard surface finish quality, sandable air drying compounds are used as the top coat on jointing systems. Some air drying compounds such as GIB Plus 4® are designed as multi-purpose and can be used for each coat in the entire joint system.

Air drying compounds contain powdered mineral fillers held together with a polymer binder (or glue) in a water emulsion. After applying air drying compound to a plasterboard surface, the water needs to evaporate to create a solid mass. This hardening, unlike setting compounds, is directly related to the speed (and temperature) at which the compound dries out. In winter with poor drying conditions, these products can take a very

GIB long time to thoroughly dry to a point where they are sandable. If it has not dried in total before painting, the product can shrink.

A minimum temperature is also required in order to form a film to bind the compound together. In most cases the minimum air and compound temperature for satisfactory application and performance of air drying compounds is 10°C.

If the compound dries below this minimum temperature, the end result is likely to be a much softer compound, that scratches readily when sanded, has poor adhesion to underlying compounds and poor paint adhesion properties.

Approximate Drying Times for Air Drying and Setting Compounds

Relative Humidity	Temperature				
	10° C	16° C	21° C	27° C	32° C
98%	26 days	18 days	12 days	9 days	6 days
94%	10 days	7 days	5 days	3 days	2 days
90%	6 days	4 days	3 days	49 hrs	36 hrs
80%	3 days	2 days	38 hrs	27 hrs	19 hrs
60%	42 hrs	29 hrs	20 hrs	14 hrs	10 hrs
40%	29 hrs	20 hrs	14 hrs	10 hrs	7 hrs

Indicates common weather conditions in New Zealand. Based on 1.5mm–2mm thickness of wet compound.

Drying And Shrinkage

At the time of usage all jointing compounds will contain water. As the excess water evaporates from the compound, varying degrees of shrinkage occurs depending on the type of compound.

Shrinkage is one of the more common failures seen and is usually the result of a coat of jointing compound not being adequately dried before the next is applied. It is avoidable however!

In general, air drying compounds shrink far more than plaster based compounds generally between 15-25%. As air drying compounds are typically applied quite thin, shrinkage does not tend to detract from the overall joint shape.

Setting compounds can shrink by 8-9% with around half of their shrinkage occurring between application and setting. The rest of the shrinkage occurs during the drying process and after setting. Setting compounds are typically used for the base coats and often are up to 1.4mm deep. Whilst the shrinkage percentage may be lower, the thicker amount means the actual amount of shrinkage can be noticeable.

When all is considered the shrinkage that can occur if a coat is not dry before the next coat is applied is in the order of 0.2mm-0.35mm. These are tiny figures, however are detectable on a generally flat wall and quite obvious in critical or glancing light conditions.

7.4 IDENTIFYING PRODUCT USE BY DATES

5kg Bags and Pails

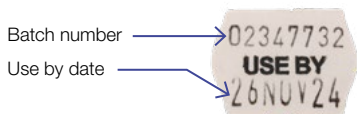

GIB® and Victor Bags



Note: The performance of GIB® and Victor compound products may be compromised if used after the date indicated.

7.5 STOPPING OF TAPERED OR RECESSED EDGE JOINTS – HAND TOOLS

These are the joints where the two tapered (recessed) edges of plasterboard meet.

Surface Preparation

- Ensure that all fixings, screws or nails, are seated just below the surface of the plasterboard. Any fixings that are driven too far into the plasterboard will cut the paper of the board causing problems such as 'popping' or 'dimpling'
- Remove any dust or loose material from the plasterboard

Mixing Instructions

- Mixing instructions for GIB® compounds can be found on the back of the bag or pail
- If hand mixing, it is better to initially mix a setting compound too thick than too thin and add water to adjust. Adding more powder to a thin mixture tends to create lumps that are difficult to mix in by hand
- If machine mixing with a paddle and drill, use a paddle with vertical sides
- Use a slow speed drill. If possible ensure the entire mixing part of the blade is under the compound whilst it is mixing. This reduces the amount of air stirred in to the product, which in turn reduces the incidence of 'pock marks' and 'pin holes'

Tips

- Paint mixing blades are not recommended (identified by the mixing part which looks like two flat wide curved ribbons). These work well in paint, but tend to mix a lot of air into the (thicker) jointing compounds
- A large battery drill is perfect for slow speed mixing, with less introduction of air to the mix compared to most relatively high speed mains power drills

Surface Preparation

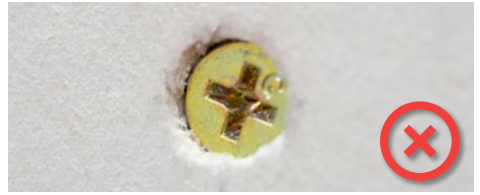

Mixing Compounds



Tools Required

Some or all of the following tools will be required depending on the work being carried out.

- Rubber Spatula, or similar, for mixing plaster
- Plastic Pail
- 75mm Chamfered Broad-knife
- 100mm Chamfered Broad-knife
- 150mm Broad-knife
- 200mm Trowel (Optional)
- 280mm Trowel
- Sanding Float
- Corner Trowel
- Dust Mask

All tools must be clean and free of any old/set plaster. Remember that as these tools are being used to create a smooth finish, any kinks or scratches in the edge of the tool will cause rough areas in the plaster. To preserve edges, do not use broad-knives for opening paint cans, etc.



First (Taping) Coat

Using a 150mm broad-knife, fill the recess formed by the edges of the sheets with GIB® jointing compound.

Centre the GIB® tape along the joint and using a 150mm broad-knife press the tape down into the GIB® compound.

GIB® Paper Joint Tape has two distinct sides. The rougher side, facing out on the roll, is bedded into the compound toward the wall surface. GIB® Paper Joint Tape can be folded for use in internal corners.

GIB RocTape® is installed similar to paper joint tape on flat joints but is not recommended for corner joints.

Draw the broad-knife (held at approximately 45 degrees to the board surface), along the joint to remove any trapped air bubbles beneath the tape.

Ensure that sufficient compound is left behind the tape to achieve a good bond.

Immediately apply a thin coat of compound over the surface of the tape. This reduces the possibility of the tape curling and wrinkling, which can lead to edge cracking.

When the compound is set, scrape back any build-up of compound along the joint.

Allow this coat to dry.



Second Coat

Apply a second coat of jointing compound with a trowel. Ensure that this coat extends at least 25mm beyond the edge of the first coat.

Feather the joints to eliminate build-up of the compound at the edges.

Allow to thoroughly dry (at least 24 hours) and scrape back any build-up of compound along the joint.

If a sandable second coat is desired: use GIB Lite Blue®, an easy sanding plaster-based compound with a 90 minute set time, developed for second coating.



Top Or Finishing Coat

Apply a finishing coat of GIB® Air Drying compound with a 280mm trowel. Joint edges should be feathered at least 25mm beyond the edges of the previous coat. Allow at least 24 hours to dry.

Using 220 grit sand paper (or finer sandpaper), lightly sand in the same direction as the joint. Take care not to scuff the face paper of the GIB® plasterboard when sanding the joint.

Tip: The finishing compound should not be harder to sand than the second coat. Refer to p.106.



7.7 STOPPING OF END JOINTS / BUTT JOINTS AND CUT EDGES – HAND TOOLS

End Joints / Butt Joints And Cut Edges

- Where possible ensure the plasterboard sheets are fixed so that the butt joint sits mid span and not on framing. If the board is already fixed, use the technique described on p.47 (where possible) to ensure a joint recess is created
- When jointing two cut edges or sheet ends which are not recessed, care must be taken to ensure the surface build-up of compound is minimised (whilst still creating a strong joint)
- The same procedure should be followed for tapered edge joints, except that the width of each stage is double that required for the tapered edge method. This results in a joint that is around 600mm wide
- Use short set time plaster compound such as GIB Tradeset® 45 for the first coat and tape in
- Take extra care when bedding in the tape to ensure that sufficient compound remains behind the tape
- Blending the resultant “bump” from stopping on an un-recessed surface is an issue, especially where critical light comes into play. The wider the joint is, the less the angle it presents to the critical light, so it is less likely that a shadow will show on the side of the joint opposite the light source

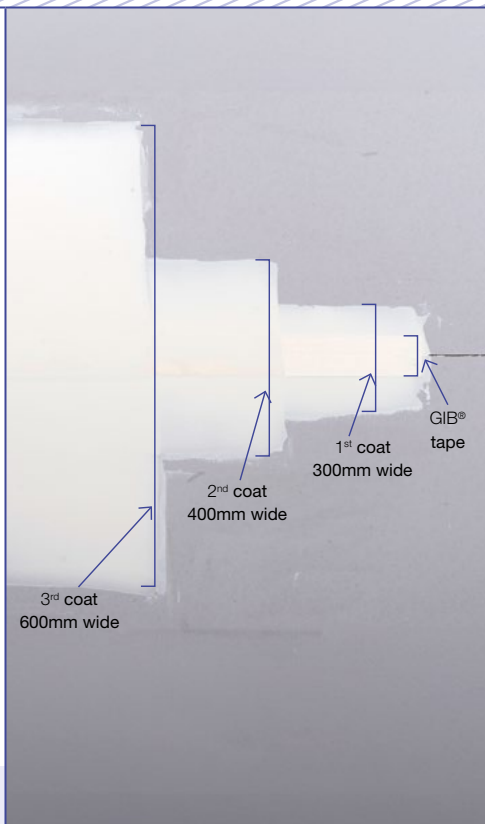

Tip: For taper edge joints the minimum width for the 3rd coat is 300mm.

7.8 JOINTING TECHNIQUES – MECHANICAL TOOLS

The mechanical tools referenced in this guide are for representative purposes only and do not preclude the use of alternatives. These include pneumatic taping machines and spring loaded flat boxes. All tools must be used in strict accordance with the relevant manufacturer's recommendations.

Tools Include

Banjo – a taping tool containing a roll of jointing tape and compound which simultaneously applies the jointing tape and compound to a joint.

Automatic Taping tool – a more sophisticated taping tool which has better control of the depth of material under the tape and so is a more reliable tool for ensuring good tape adhesion in hot weather. However, as they can be expensive and difficult to clean, these tools do not lend themselves to applying setting compounds, and consequently are seldom seen in NZ.

Box – a box shaped metal vessel with a slot at the top and adjustable wiping surface to control the flow to the joint, and the shape of the joint. Available in different widths for the different coats of the joint and handles to suit the operator.

Corner Finishing Tools – can apply joint compound to internal corners.

Preparation

- Ensure that all fixings, screws or nails are seated just below the surface of the plasterboard. Any fixings that are driven too far into the plasterboard will cut the paper of the board causing problems such as 'popping'
- Tidy up any damaged areas of plasterboard such as broken corners. It is usually easier to remove these completely and fill them with a plaster based (setting) compound prior to continuing
- Remove any dust or loose material from the plasterboard
- Mixing instructions can be found on the back of the compound packaging

Refer to p.91 for mixing detail.

Mechanical Stopping With Banjo And Box

A banjo taping tool applies bedding compound and tape in one step and is an efficient method for taping-in of medium/large areas of plasterboard walls or ceilings.

Note: This device places the tape on top of a layer of plaster, the depth of which is not easily controlled. Be aware that lack of compound under the tape can cause tape adhesion issues.

Always place the banjo on the maximum setting when applying the compound in warm / hot weather.

First Coat – Banjo

- Mix the bedding compound with a drill and then carefully adjust the water content until it can just be poured from one bucket to another

Note: if the compound is too thin, the tape will tend to slide along the recess and may peel or drop out.

- Place and lock the roll of GIB® tape onto the spindle and thread inside the banjo and along the top (handle) inside edge as illustrated. Pour the compound into the banjo cavity underneath the GIB® tape. Close and clip the side panel
- Place the coated tape centrally in the joint. Hold the tape with one hand whilst pulling the banjo along the joint with the other hand (make sure that the nose of the banjo is held against the surface of the joint)
- Adjust the banjo control knob so that a layer of approximately 2mm thick of compound is on the underside of the tape and is not excessively squeezed out from the edge of the tape when applied
- After placing the tape at the end of a joint, cut the tape neatly with a broad-knife
- Using a 150mm broad-knife held at about 45 degrees, press the tape down into the compound and at the same time removing excess compound
- When the compound is set (or dry) scrape back any ridges

Note: Do not allow setting compounds to set in the banjo.



Second Coat – Flat Box

The flat boxes used for second coating of tapered joints are typically 200mm-250mm wide. They automatically dispense the correct amount of joint compound and feather the edges in one pass. The adjustable blade holder fine tunes the 'crown' for proper compound distribution and shape. The boxes are controlled by a specially designed handle.

To start, place the adjustable notch for the wiper blade on the second lowest setting and then adjust to suit the job. The advantage of using flat boxes for tapered joints is the speed with which joints can be filled. They generally will not require any further touch-up if set up and operated correctly.

- Mix the compound with a drill and adjust to a 'pourable consistency', i.e. requires a minimal effort to 'push' out of the box but not so thin that it will 'run' out of the box, or slump on the wall during use
- Using a scoop, broad-knife, or pump; fill the flat boxes with compound
- Place the box on the surface of the board as flat as possible. Place one hand just below the head of the box handle (to control application pressure to force compound out of the box) and the other hand at the other end (to control the 'brake' and keep the box running parallel to the joint)
- Allow the compound to dry thoroughly before scraping back any ridges or build up

Note: Do not allow setting compounds to set or air-drying compound to dry in the flat box.

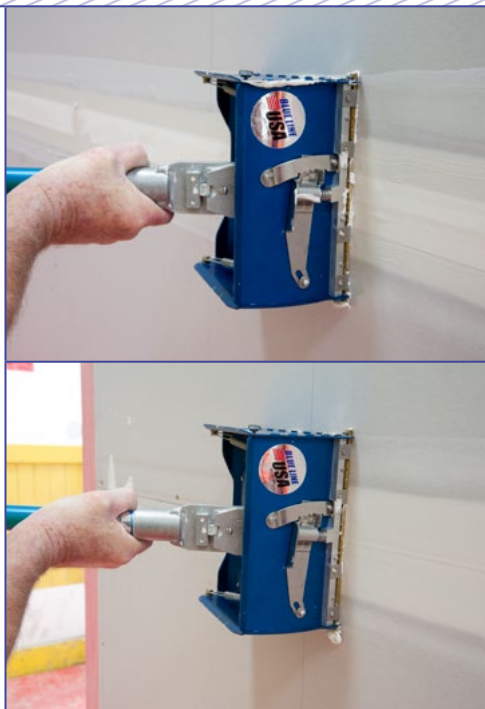

Top Or Finishing Coat – Flat Box

A 300mm flat box is typically used with specifically formulated air-drying finishing/topping compounds for the top/finishing coat.

The air drying compound should be thoroughly mixed and if necessary, the consistency adjusted to give a smooth ‘tear free’ finish (but not so thin that it will ‘run’ out of the box during use).

The ‘setting’ of the flat box is typically two notches above the bottom setting. However, adjustment may be necessary.

The box is adjusted and operated to leave a very smooth surface free from lumps, ridges or scratches.

Note: Don’t allow air-drying compound to dry in the flat box. Placing too much compound in one application may result in bubbles, pin holes, and streaks.

Please read notes below to understand some of the issues that can be created by the use of machine tools.

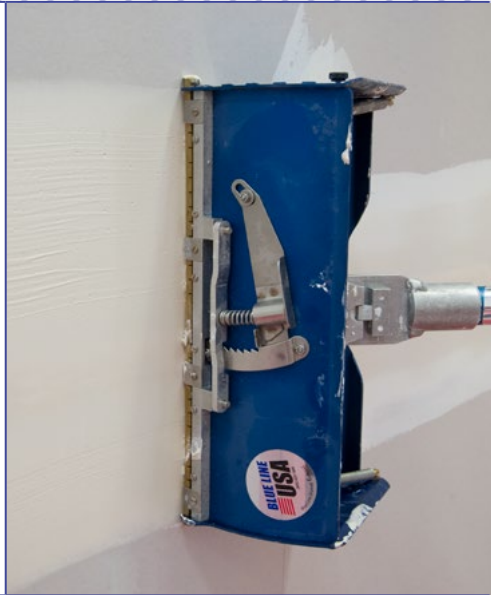

Possible Issues With Machine Tool Application

1. When using machine tools, the compounds placed in them have to be diluted (compared with that required for trowel application) to achieve a viscosity that flows readily through the machine.
 2. The addition of water will result in:
 - Greater shrinkage as the compound dries
 - Longer drying time due to a greater amount of water to dry
 - Possibility of delayed shrinkage as more water soaks into the substrate (then has to dry back through the joint)

Longer drying times in cooler conditions must be allowed for before the next coat is applied. Delayed shrinkage may occur if the next coat is applied before the first has dried. Make allowances for this, by warming the rooms to be stopped until the joints are dry.
 3. Placing tapes with an automatic taping tool is quick and easy. However it is very easy to force too much compound from under the tape. This can result in poor tape adhesion in summer, as the compound can dry out more quickly. In extreme situations this can lead to the plaster in the compound not being able to set. Be aware and check material depth when starting (to ensure the machine set up and methods of use are appropriate).
 4. Horizontally fixed board not supported with framing adjacent to the joint, can result in a variation in the depth of the taper between the two boards. Machine tools can easily place a thin layer on only one edge (this can result in tape adhesion issues).

7.9 NAIL AND SCREW STOPPING

If good fixing practice has been followed, there should be no fixings in the middle of the plasterboard sheet on the wall. However, this cannot be avoided on ceilings or in fire rated or noise control systems.

Critical light areas

This method takes longer, but ensures that no air is trapped between the screw or nail head and the first coat of compound. This reduces the possibility of dimpling.

- For the first coat, press a mixed GIB® plaster based compound into the fastener indentation with a 25mm putty knife, then wipe off the excess
- Do the second and third coats as per the normal jointing procedure

Non-critical light areas

- For the first coat, wipe the compound across the top of the screw or nail head, as per normal towelling application. Use a 100mm broad-knife for the first two coats of compound
- Do the second and third coats as per normal jointing procedure

For either method, leave the first two coats to dry for at least 24 hours before applying the finishing coat with a 150mm broad-knife. Leave to dry for at least 24 hours and then lightly sand with 220 grit sandpaper.

For over-driven screws, use a short set time setting compound to minimise the time and amount of water that can soak in and swell the board paper. Leave for a longer period to dry compared to normal screw stopping. These actions may reduce the incidence of “popping” or “dimpling” on these surfaces.

7.10 CORNERS AND FINISHING TRIMS

External Corners

These can be finished with:

Paper Faced Trims

- GIB® Goldline® profiled paper faced trims
- GIB® UltraFlex® high impact reinforced corner trims
- GIB® Levelline® reinforced corner trims

Metal Trims

- GIB® Slim Angle metal trims

GIB® Slim Angle

- Mechanically fix at 300mm max centres on alternate sides of the corner (fixings should also be placed on both sides at each end of the trim)
- GIB® Slim Angle can be fixed with GIB® Grabber® screws or staples (minimum 10mm)
- Apply a first coat of GIB® setting compound, using a 150mm broad-knife or 200mm trowel
- When hard, lightly scrape back using a broad-knife or the edge of a trowel
- Apply a second coat of GIB® setting

compound using a 200mm trowel. When hard, lightly scrape back

- Apply a third coat of a GIB® air drying topping compound using a 300mm trowel and leave to dry
- When thoroughly dry, lightly sand in the direction of the joint with 220 grit or finer sandpaper, taking care not to scuff surface paper of the plasterboard

Internal Metal Corner Trims

Inside corners are installed similarly to outside corners except that only one top coat of a GIB® finishing compound is required. A corner trowel may be used to apply and smooth the compound if desired.

Apply similar installation methods for the other metal trims. Casing beads can be secured using GIBFix® adhesive.

Note: Bullnose external corners are not permitted in fire rated systems.

7.11 SQUARE STOPPING

Square stopping of wall and ceiling junctions can be done with paper joint tape or paper faced trims.

Follow the internal corner installation instructions outlined on p.99.

Paper Faced Trims

- Paper faced trims such as GIB® Goldline® Platinum Tape-on trims, GIB® UltraFlex® and GIB® Levelline™ are installed by embedding directly into the joint compound
- A slightly thinned mix of a GIB® setting compound is recommended for the installation of paper faced trims because they provide maximum adhesion to the paper surface of these trims
- When installing external Bullnose Corners, check that the plasterboard edges do not extend past the corner of the framing substrate on either side. If the plasterboard edges do protrude, trim them back before commencing installation
- Make sure that products such as GIB® UltraFlex® are fully supported by the two plasterboards neatly butted up to each other. Otherwise a void is left behind the trim, which will become a weak/fail point if the corner is impacted at some point during its life
- Apply a 75mm wide band of GIB Tradeset®, GIB LiteSet® or GIB MaxSet® to each side of the GIB® plasterboard corner
- Cut trim to required length and position over the joint compound. Allow 10mm at the bottom for expansion and contraction of framing members. Mitre any corners which will be meeting other trims at corners
- Press the trim firmly into the compound evenly along its full length, embedding the trim and forcing out excess compound. The installation of the trim may be performed with the aid of a corner roller. It is crucial an adequate amount of compound remains under the tape for good adhesion
- Using a 100mm broad-knife, wipe off surplus compound and eliminate all air bubbles under the paper. Be careful not to remove all compound
- Using additional compound, flush the joint with a 150mm broad-knife or trowel. Remove any excess jointing compound on the nose of the trim by wiping with a damp sponge
- Allow to harden and dry, then apply a light top coat of GIB® air dry compound (in a band of about 200mm wide). This is done using a large (250–300mm wide) broad-knife or trowel
- Feather the compound by drawing the knife along the trim, with one edge of the blade riding on the nose of the trim and the other on the surface of the GIB® plasterboard
- Repeat for the other side of the trim and allow to dry
- Once the previous coat is dry, apply a second top coat of GIB® finishing compound. Feather the edges of each coat about 50mm beyond the preceding coat. When the top coat is completely dry, lightly sand, taking care not to scuff the face paper of the GIB® plasterboard

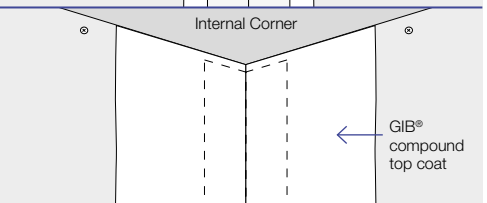
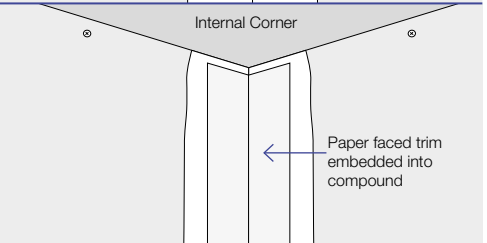
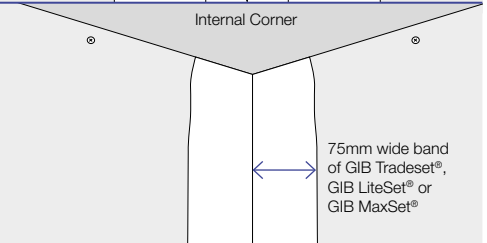
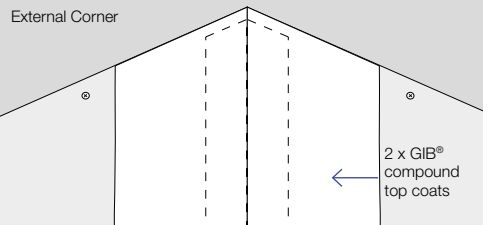
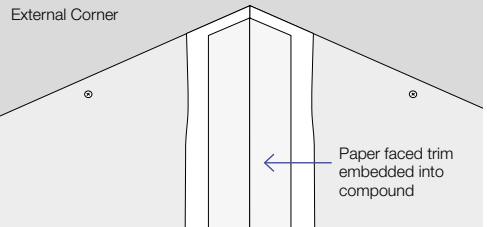
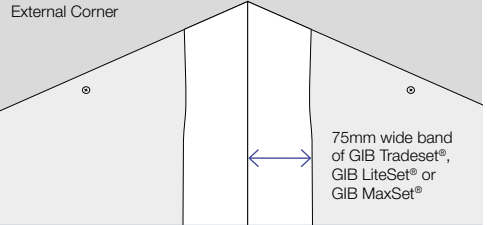

Tips:

- Multi purpose air drying compounds may be used to adhere GIB® UltraFlex® and GIB® Levelline® trims, however they may take a long time to dry
- Generally air drying compounds have a higher shrinkage. Filling of any voids behind tapes with air drying compounds is not recommended, voids should be filled with setting compounds

7.12 NEGATIVE DETAIL

Negative details can be formed at plane junctions and at junctions between dissimilar building materials. There are many different effects that can be achieved and some suggestions are shown below.

- GIB® Goldline® Platinum GR reveals, or the GIB® Rondo® P50 metal reveals, can be used to create straight, evenly spaced details that clearly define the junction
- Care needs to be taken to ensure that joints are straight and that adequate clearance is provided for the flange of the reveal trim

Note: Allow a 14mm–17mm gap for the top flange of the GIB® Goldline® Platinum trim or a 12mm gap for the Rondo® P50 metal reveal trim

Negative Detail

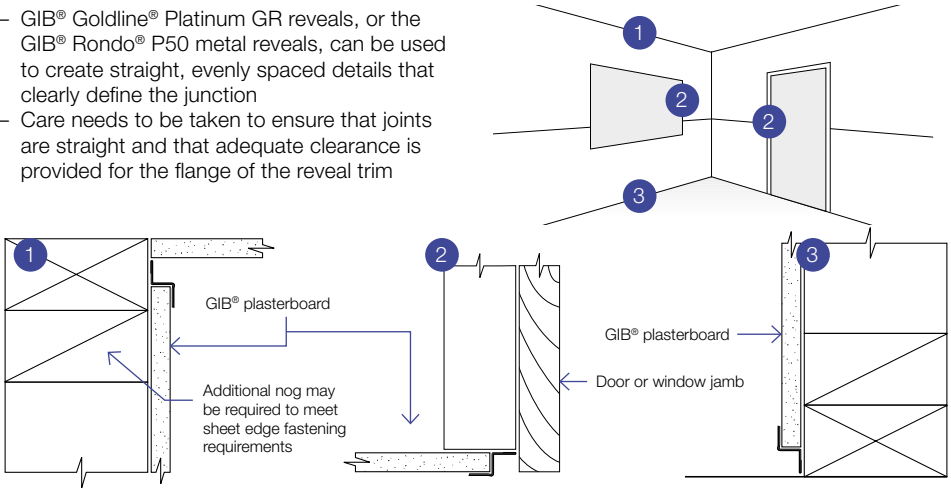

7.13 TIMBER SCOTIA

General Timber Scotia Installation Detail

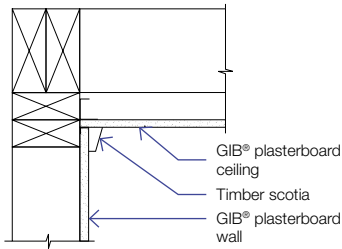

Timber Scotia in a GIB® Fire Rated Systems

If installing timber scotia over a GIB® Fire Rated Wall or Ceiling Junction apply a bead of GIB Fire Soundseal® at the wall and ceiling junction prior to installation of the scotia as per the below details.

For further installation guidance on GIB® Fire Rated Systems refer to the GIB® Fire Rated Systems Manual.

Timber Scotia for Single Layer GIB® Fire Rated System Junction

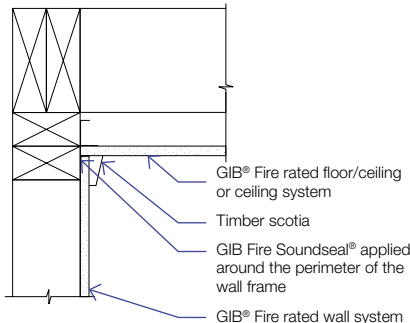

Timber Scotia for Double Layer GIB® Fire Rated System Junction

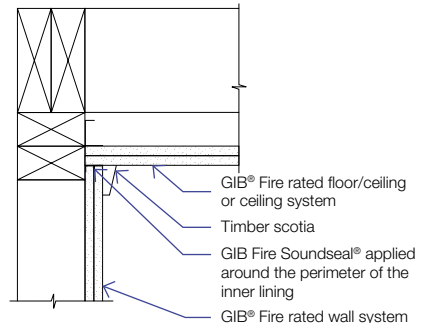

Preparation

- Always fix GIB-Cove® prior to skim coating or any paint application
- Ensure that all joints that are not to be covered with GIB-Cove® are stopped first. For accurate placement of GIB-Cove®, mark walls with a chalk line (either 50mm, 55mm, 75mm or 90mm) from the wall/ceiling angle. Measure and cut the GIB-Cove®, using a fine toothed saw and a mitre box. Tidy the cut edges using sandpaper
- If cove work has not been done before, it is suggested that slight over-ordering is done so a short length is available to practice cutting the angles up the right way
- It is also suggested that a chalk line be used around the room to establish the correct position on the wall for the bottom of the GIB-Cove®
- Measure the GIB-Cove® to get the correct measurement for the chalk line set up. Do this by placing a straight edge from each edge of the cove, and measuring the length to where they bisect. Use this measure as the chalk line datum
- Align the cove on the chalk line to ensure all the cove is installed at the same level
- Joints in long runs of GIB-Cove® should be mitred (not square cut)
- Mix GIB-Cove® Bond to instructions on the back of the bag

Note:

It is recommended to install the GIB-Cove® before stopping sheet joints to avoid any possible adhesion issues between the GIB-Cove® and wall lining.



Scan to view GIB® installation videos



Application

- In smaller rooms (e.g. toilets and bathrooms) fix shorter lengths of GIB-Cove® first. This allows the longer more flexible pieces to be placed last for a tight fit
- Apply the GIB-Cove® Bond in two strips (about 10mm thick) along the entire length of each edge of the GIB-Cove® where contact will be made with ceiling and wall
- Where friction joints or deflection heads are used in non Fire Resistant Rated commercial light steel framed construction, the GIB-Cove® may be adhered to the ceiling only and sealed to the wall using a flexible sealant
- Carefully place the first length along the chalk line and press firmly into position. Hold in place until the adhesive grips
- Remove excess GIB-Cove® Bond using a broad-knife and clean the joints with a moistened brush or sponge
- Where walls and ceilings are uneven, it may be necessary to hold the GIB-Cove® in position for longer until the GIB-Cove® Bond has set. This is done with partly driven nails or screws supporting the edge of the GIB-Cove®. These can be removed and the holes stopped when the adhesive has set. Note: GIB-Cove® Bond must be discarded after it shows signs of stiffening



Shipping and Handling Tips

- Always have GIB-Cove® top stowed
- Use packaging protection to protect the edges from strapping and damage
- The best way to carry GIB-Cove® is to use a two person lift with the GIB-Cove® on its edge. This prevents the lengths sagging which could damage the GIB-Cove® and result in post installation issues
- Carrying stacks of a maximum of 5 lengths at a time ensures that the GIB-Cove® is fully supported to avoid sag



7.15 SKIM COATING

All paint products and systems must be applied in strict accordance to the manufacturer's recommendations.

Level 5 Skim Coating

Skim coating is one method to achieve a Level 5 Finish as specified in AS/NZS 2589:2017. A Level 5 Finish is defined as being 'characterised by a parity of texture and porosity' over the entire surface of the plasterboard, jointing and fastener points.

Skim coating can be achieved by applying jointing compound to the surface with a trowel. This creates a uniform texture (and also hides bumps, steps and joint protrusions).

Alternatively, high build paint systems can be used. These are comprised of a specially formulated high build coating which is very efficiently applied with airless spray equipment. These also do an excellent job of masking surface texture variance, but may not correct irregularity in the board surface.

Trowel Application of a Skim Coat New GIB® Plasterboard

This surface is the simplest to skim coat, however care should still be taken as problems can occur through incorrect application.

Any of the GIB® ready mixed air drying range of compounds can be used for trowel applied skim coating. Consider weather conditions when making the choice to ensure optimum sand-ability is achieved. See p.98 for further detail.

- Joints should be prepared in the normal manner up to the finish coating stage. Allow plaster to dry thoroughly
- Apply a skim coat of approximately 0.25mm–0.5mm (but no greater than 1.0mm) of the GIB® compound of choice to the entire surface of the board
- Leave the skim coated area until completely dry
- Sand by hand or a pole sander, in one direction with 220 grit or finer sandpaper
- Ensure surface is free of dust. Seal with a wallboard sealer prior to decoration. Use an appropriate pigmented-oil based or acrylic sealer for areas that will be exposed to moisture

Existing Plasterboard – Undecorated

These areas would typically include board that has been fixed to the wall and has not been stopped. When the board has been exposed to the elements for an extended period of time face paper may fade.

1. Remove any dirt or oil with detergent. Allow to thoroughly dry before continuing
2. Seal the entire area with an appropriate pigmented-oil based or acrylic sealer
3. Lightly sand the entire area with 100–120 grit sandpaper
4. Apply a skim coat of approximately 0.25mm–0.50mm of GIB® air drying compound to the entire surface of the board
5. Leave GIB® air drying compound to completely dry. Sand with 220 grit or finer sandpaper, in one direction, using either a pole sander or sanding block. A vacuum power sander can also be used
6. Ensure surface is free of dust. Seal with an Acrylic Wallboard Sealer prior to decoration. Use an appropriate pigmented-oil based or acrylic sealer for areas that will be exposed to moisture

Existing Plasterboard – Painted Surface

1. Clean the entire area to be skimmed with water and a scouring pad. Use an alkaline cleaning solution in water to remove any dirt/oil. Thoroughly rinse with water
2. Sand painted areas to be skimmed with 100–120 grit sandpaper
3. Apply a skim coat of approximately 0.25mm–0.50mm of GIB® air drying compound to the entire surface of the board
4. Leave GIB® air drying compound to completely dry. Sand, with 220 grit or finer sandpaper, in one direction, using either a pole sander or sanding block.
5. Ensure surface is free of dust. Seal with an Acrylic Wallboard Sealer prior to decoration. Use a pigmented oil based sealer for areas that will be exposed to moisture

Existing Plasterboard – Previously Wallpapered

This surface would be commonly encountered in renovation work where old wallpaper has been removed and skim coat is required. This surface presents special problems because it is usually rough, uneven, has loose paper and is covered with wallpaper glue.

1. Rinse area twice with warm water and leave to dry
2. Repair any damaged areas to the core of the plasterboard with a short set compound such as GIB Tradeset® 20 or 45. Ensure plaster is completely set and dry before proceeding

3. Seal the entire area to be skim coated with a pigmented oil based sealer. (**Note:** Water based acrylic sealers must not be used on existing wallpapered plasterboard)
 4. Sand the entire area with 100–120 grit sandpaper
 5. Apply approximately 0.25mm–0.5mm thick coat of GIB® air drying compound
6. Leave the GIB® air drying compound to completely dry. Sand with 220 grit or finer sandpaper, in one direction, using either a pole sander or sanding block
 7. Ensure surface is free of dust. Seal with an Acrylic Wallboard Sealer prior to decoration.

7.16 SANDING

Winstone Wallboards has a range of compounds to cater for different drying conditions experienced in New Zealand.

The GIB Trade Finish® compounds have different sanding characteristics. For example, during winter a harder finishing compound can be used to avoid scratching and swirl marks. During summer, an easier to sand finishing compound can be selected to speed up sanding (and where a lot of hand sanding is required).

When drying conditions are not ideal, problems may arise with softer compounds scratching too easily and leaving “swirl” marks after sanding. A harder finishing compound is recommended in these conditions (e.g. a switch from GIB Trade Finish® Lite to GIB Trade Finish® Multi or from GIB Trade Finish® Multi to GIB Trade Finish® Heavy Weight in colder conditions).

When selecting a harder finishing compound, it is important to remember the coats underneath need to be just as hard (or harder) and not softer. Using softer compounds underneath a hard compound can be problematic if the top coat is completely sanded away. This can manifest as grooves or trench marks being created rapidly as the softer compound underneath is removed more easily; and may give the impression the top coat has delaminated when it has not. To avoid this, use the same compound or a softer compound for the top coat.

Ease Of Sanding

The plaster based GIB Tradeset® range and GIB MaxSet® taping compounds are both much harder than any of the GIB® air drying compounds, so there are no compatibility issues.

GIB LiteSet® is an easy to sand and scrape taping/base coat joint compound. It is softer than GIB Tradeset® and GIB MaxSet® but harder than GIB Lite Blue®. Any of the GIB® air drying compounds can be used as the top coat on GIB LiteSet®.

Refer to p.106 for a list of GIB® compounds ordered from easiest to hardest to sand.

Machine sanding

Purpose built vacuum sanding machines can be used to significantly reduce airborne dust, as well as the time and effort taken to sand the joints (and general clean-up time).

- Follow the manufacturer’s instructions. Use 220 grit paper
- When sanding, position the sanding head so that it is in contact with the joint. Press lightly on any feathered edges so that the paper is not scuffed excessively
- Be careful when using a machine sander on nail and screw hole areas. If the paper surface is scuffed excessively, it may show through the finished painted surface as a variance in texture or sheen, diminishing the overall quality of the finish

Pole sanding

- Pole sanding is a dry sanding technique
- Round pole sanders have no corners to dig into the surface and use standard sanding disks like a machine sander
- Rectangular pole sanders are good for corners
- The main drawback with pole sanding is the volume of dust created. Ensure all safety issues are addressed by wearing suitable personal protective equipment before using these tools

Sanding Blocks

These are block shaped sanding pads, handy for corners and small sanding areas.

Sandpaper

Sanding disks come in many types.

Although they may state the same grit size, the abrasive material used also plays a part in how quickly the surface can be sanded. If too abrasive and drying issues are experienced, swirl marks may be left in the surface of the joint.

If problems are experienced with one sort of sanding disk, try another. If the problems are on-going, change to a harder air drying compound, or heat the premises to be stopped (to ensure the joint has dried), and is therefore sandable.

Sanding In General

- Always sand in the direction of the joint
- Try to minimise “scuffing” of the paper surface next to the joint
- If scuffed excessively, the “furry” quality of the sanded paper will show as a different texture through the painted surface, creating a visible difference in sheen
- Be aware that damp conditions (such as foggy weather), can cause the surface of the board to absorb moisture, and be far more likely to

scuff badly when sanded. Either heat the room, or use worn sand paper disks to ensure a less abrasive effect is applied to the paper

GIB Ultraline® plasterboard has a surface coating on the paper which is far more resilient to sanding compared to conventional paper surfaces. This is one of the reasons why this board is touted as a Level 4-plus product.

7.17 JOINT SYSTEMS RECOMMENDATION

The GIB® plasterboard range of air drying compounds caters for different weather conditions caused by seasonal change.

Air drying compounds (the compounds in pails) are held together by binders (glue). When these binders coalesce and cure, they bind the filler particles (mostly limestone) together which causes the product to go hard. How hard a specific compound will be to sand is dictated by temperature as it cures.

- The warmer the weather, the harder the product will become to sand
- The colder the weather, the softer the same product will become to sand

This can be seen when a compound that is great to machine or hand sand when applied on a hot summer’s day is seen to be much easier to sand if applied on a cold winter’s day. This can result in the winter application sanding too easily, resulting in swirl marks that ruin the finish when sanded, it may also be easily damaged if trade folk brush past a dry but not painted joint.

Conversely, a harder compound may sand well in winter, but become too hard if applied in very hot weather, or if in-line with sun shining through a window in summer resulting in direct UV penetration.

This may result in the product becoming “glazed” as it is sanded and very difficult to sand.

To resolve this issue there is a range of GIB® compounds, each of which is optimised for warm, cold, or in-between weather use. It is up to the trades person to select the product most suited to the condition to ensure ease of sanding and quality of finish.

The GIB Trade Finish® range was developed to ensure a product is available that has similar rheological (trowelling) properties through the range, but different sanding characteristics to suit different seasons.

The harder to sand products should be used in the colder weather (winter). In these conditions the binder will not cure as hard, however it will still be hard enough to resist swirl marks, scratching and trade damage.









The easiest products to sand should be used in warm weather, when the binder will cure harder. This creates a surface that is easy to sand and can be machine sanded in summer without leaving swirls and dig marks.

The table on the page 106 shows the sanding characteristics of each GIB® compound.

Remember

- Harder sanding products in cold seasons
- Easier sanding products in warmer weather

Change from one to the other for the cold and warm seasons if ultimate ease of sanding without swirl marks and scratching is desired. Use the chart to guide you to figure what will work best for you.

		Sanding/Scrape	GIB® Air Drying Compound	Setting Compound
Weather Conditions ↑ Warmer ↓ Colder	Very easy sanding		GIB Trade Finish® Extra Lite 	
	Easy sanding		GIB Trade Finish® Lite GIB Plus 4® 	
	Moderate sanding		GIB Trade Finish® Multi 	GIB Lite Blue® 
	Harder to sand		GIB Trade Finish® Heavy Weight 	GIB LiteSet® 
	Easy to scrape			GIB Tradeset® 
	Scrape while "green"			GIB Maxset® 

7.18 PAINTING

All preparation and painting work should be undertaken in accordance with AS/NZS 2311 'Painting of Buildings' and with the relevant paint manufacturers recommendations.

Surface Preparation Prior to Painting

Ensure all stopped surfaces are dry, sanded smooth and that any dust, oil, grease or dirt has been removed with a soft brush, damp soft cloth or a vacuum cleaner.

Ensure all windows, electrical fittings, furniture, covers, doors (or other components which are not to be painted), are masked out, covered or protected throughout the painting process.

Guidelines

- Flat paints tend to minimise visibility of any minor surface imperfections but may not be suited to areas that need regular cleaning
- Light tone colours tend to diffuse light, which helps in disguising any minor surface imperfections
- Avoid the use of harsh lighting (e.g. 'wall washers') or situations such as windows extending to the wall or ceiling line. If these situations are unavoidable consider the use of a Level 5 pre-decorative skim coat

- As a general rule 'cut in' around edges and doors with a brush and then apply the remainder of the paint system with a 6mm –10mm nap roller sleeve
- Always maintain a 'wet edge' with the roller and lay off the final coat in one direction, preferably parallel to the dominant light source
- On faded GIB® plasterboard, use a pigmented-oil based or acrylic sealer as the first coat

NOTE: BACK ROLLING

Where the paint system will be applied by airless spray equipment, it is essential to 'back roll' the final coat of paint using a roller with a fine nap. This is to create a 'soft' orange peel effect which aids in disguising plasterboard jointing, or any other minor surface imperfections.

Painting Existing Walls

Follow the paint manufacturer's instructions regards preparation and methods of application.

Wallcoverings

New Surfaces – Follow the application instructions of the wallcovering manufacturer.

8.0 REPAIRS AND MAINTENANCE

8.1 PLASTERBOARD REPAIRS

Plasterboard repairs are necessary for a number of reasons. Cracks in plasterboard or sheet joints are generally the result of movement of a building. A common example of this is where joints are made at the high stress points above and/or below the corners of windows and doors. If you notice these cracks forming, it is suggested you leave these for approximately 1 year before repairing. This allows the building to settle and should reduce the likelihood of problems recurring, but is no guarantee the same problems will not occur.

We also include some useful pointers when repairing dings and holes in GIB® plasterboard. In addition we cover the mounting of fixtures to GIB® plasterboard when fixing into a stud with screws or nails is not possible.

Note: These instructions are NOT suitable when conducting repairs to fire rated walls or ceilings. Similarly, mounting fixtures in GIB® fire rated walls **MUST BE AVOIDED** as this will affect the performance of the fire rated system (see GIB® Fire Rated Systems literature).

Tools

Some, or all, of the following tools will be required depending on the actual work being carried out.

- Rubber spatula (or similar) for mixing plaster
- Plastic Bowl
- 150mm Broad-knife
- Sanding Block
- Sharp Craft Knife
- 280mm Trowel

All tools should be clean and free of any old and set plaster. Stainless steel tools are recommended as these are less likely to corrode.

Tip: A light spray with lubricant and a wipe with a cloth or paper towel will also help keep metal tools in the best condition.

Remember that as these tools, e.g. broad-knives, are being used to create a smooth finish, any kinks or scratches in the edge of the tool will cause rough areas in the plaster. Do not use broad-knives for scraping, opening paint cans, etc.



Repairing Dings, Cracks and Scratches

The following procedure should be used for repairing dings, cracks and scratches less than 2mm deep.

- Sand the area around the repair to ensure the best adhesion between the compound and the painted surface
- Using a broad-knife apply GIB RediFilla® to the damaged area
- Leave the compound to dry (at least 24 hours for areas up to 1mm thick and 48 hours for thicker areas)
- Using 220 grit sandpaper (or finer), sand the area in one direction (not in a circular motion)
- Decorate as required



Repairing Minor Holes

Occasionally a plasterboard patch will be required to repair a damaged wall.

- GIB RediFilla® is a pre-mixed, air drying compound that can be used to repair dings, marks, dents, and blemished surfaces on plasterboard and other surfaces
- It's an easy-sand product to which paint adheres, so can be used as a total repair system for minor repairs
- GIB RediFilla® is available in handy 2 litre pails

Minor holes or construction of small joints for one-off hole repairs

- GIB TradeFilla® is a setting compound. When mixed with water, it has a 10 minute working life
- It changes viscosity during its working life, enabling differing surfaces to be filled by the same product (e.g. repairing a grazed or rough surface when thin, and filling holes as it thickens up)
- When dry, GIB TradeFilla® is a sandable product to which quality paints adhere
- It can be used for the entire repair process, or for the first two coats (in conjunction with GIB® air drying compound as the top coat)
- GIB TradeFilla® is available in a 5kg bag

Larger or multiple repairs

GIB Tradeset® 20 is a setting compound that sets hard in approximately 10–30 minutes when mixed with water.

- Complete drying may take a further 24 hours depending on how thick the compound is applied
- GIB Tradeset® 20 is available in 5kg and 20kg bags
- Tip: As a guide when mixing powder compounds, sprinkle in just enough powder until the water no longer soaks through. If water soaks through, sprinkle in a little more powder
- Tip: It is preferable to mix the compound too thick than too thin. It is easier to add water than to add powder
- Leave the mixture to soak for approximately 30 seconds
- Mix using a rubber spatula or similar for approximately 90 seconds until the mixture is smooth and lump free.

Drying Time

Joint compound must be allowed to dry before it is painted.

Approximate drying times for air drying compounds is a minimum of 24 hours between coats (and longer if the conditions are cold and/or damp). See p.92.

Water, air and mix temperatures should be kept above 10°C. If temperatures are low, place a fan heater in the room and leave on a moderate setting (no more than 20°C) for a couple of hours. Complete the job, then leave the fan heater going for 24 hours, with the door open to allow exchange of air into the room. This will ensure the taping coat dries out in a reasonable time.

Buy only as much product as is necessary to complete the work you will be doing.

Clean Up

Leave any spilt material to harden before scraping up and disposing of to landfill. A little warm water on a cloth is normally sufficient to remove any residue.

Scan to view GIB® installation videos



Repairing Small To Medium Holes (up to 150mm in diameter)

Winstone Wallboards recommends the use of GIB Tradeset® 20 or GIB TradeFilla® for base coats and a GIB® drying compound such as GIB Plus 4® or GIB RediFilla® for the finishing coat.

1. A GIB® plasterboard patch will be required for holes up to 150mm in diameter
2. Cut away the damaged area to a neat rectangular hole
3. Sand the area around the repair to ensure the best adhesion between the compound and the painted surface
4. Cut a piece of GIB® plasterboard that is approximately 20mm longer than the hole, but small enough to fit through the hole
5. Place a 60mm flat head nail through the centre of the piece of GIB® plasterboard and coat the ends with compound
6. Insert the patch into the hole and pull toward the front using the nail
7. Once hard (approximately 1 hour) gently push the nail back through the patch
8. Cut a piece of GIB® plasterboard to loosely fit the hole
9. Use compound to fix the patch in place
10. Apply compound over the joints
11. Immediately place a length of paper jointing tape over the four edges into the compound, using the broad-knife to remove any air bubbles under the tape
12. Once the first coat is hard, apply a second coat of compound over the joint areas, feathering the edges, so that it is approximately 250mm wide
13. Leave the compound to dry for at least 24 hours
14. Scrape away any rough edges using a broad-knife
15. Apply a thin finishing coat over the patched area
16. Leave to dry and sand smooth
17. Decorate the area as required

Note: These instructions are NOT suitable when conducting repairs to fire-rated walls. Similarly mounting fixtures in fire-rated walls **MUST BE AVOIDED** as this will affect the performance of the fire rated system.

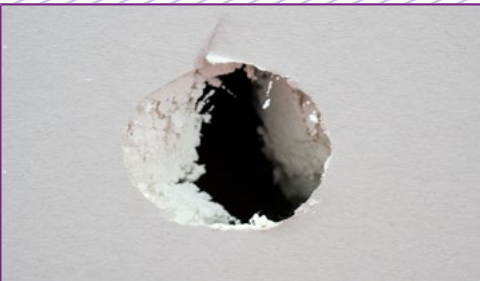

Repairing Large Holes (over 150mm in diameter)

For larger holes it becomes necessary to cut away the damaged area back to one or two studs and use a GIB® plasterboard patch.

- Cut away the damaged area to either one or both studs surrounding the damage to form a rectangular hole
- Sand the area around the repair to ensure the best adhesion between the compound and painted surface
- Cut a length of GIB® plasterboard that is 100mm wide and 100mm longer than the height of the hole.
- Tip: If you have cut away to both studs this will not be required. Fixing to both studs is the easier method of repair, but is not always possible
- Using GIB Tradeset® 20 or GIB TradeFilla®, fix the plasterboard to the side of the hole which is not over the stud
- Cut a new piece of GIB® plasterboard to fit the hole and fix this to the stud(s) and/or plasterboard back-block
- Apply a coat of GIB Tradeset® 20 or GIB TradeFilla® over the four joints using a broad knife
- Immediately place a length of paper jointing tape into the compound, using the broad knife to remove any air bubbles under the tape

Tip: If any blisters appear in the tape this is usually an indicator that insufficient compound is present behind the tape. Lift the area of tape away using the corner of the broad-knife, apply a small amount of compound and press the tape back into the compound once more.

- Once the first coat is hard apply a second coat of GIB Tradeset® 20 or GIB TradeFilla® over the joint areas, feathering the edges, so that it is approximately 250mm wide
- Leave the compound to dry for at least 24 hours
- Scrape away any rough edges using a broad knife
- Apply a thin coat of GIB RediFilla®, or any other GIB® air drying compound, over the patched area
- Leave to dry and sand smooth
- Decorate the area as required



8.2 MOUNTING FIXTURES TO GIB® PLASTERBOARD

The first option for attaching fixtures to plasterboard walls is to try and locate any framing behind the fixture. If it is not possible to make use of the framing to attach the fixture, there is a wide range of proprietary fastenings for attaching fixtures of varying weights.

Strictly follow the manufacturer's instructions regarding weight limits.

Tools

Some, or all, of the following tools will be required depending on the actual work being carried out.

- Drill and bits
- Screw Driver

Systems

- Some options are shown in the diagrams on the right hand side of this page
- These can be used in GIB® plasterboard walls that are NOT fire-rated
- They are suitable for fixing lightweight items such as pictures, coat hooks and fire extinguishers (up to 20kg), etc. in situations where fixing into the stud with nails or screws are not possible.
- These systems are NOT suitable for heavy items such as shelving, cupboards or vanity units which require additional framing for support
- The fixing method depends on the thickness of the GIB® plasterboard and the distance that the fixture hangs out from the wall

The following guidelines are indicative only. If in any doubt, consult the fixing manufacturer or distributor. The capacities shown are given for 10mm GIB® Standard plasterboard.

Allowable Fixture Weight 3kg

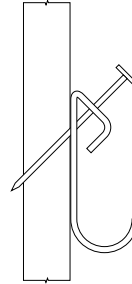

Allowable Fixture Weight 6–8kg

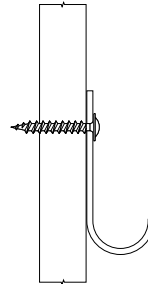

Allowable Fixture Weight 8kg

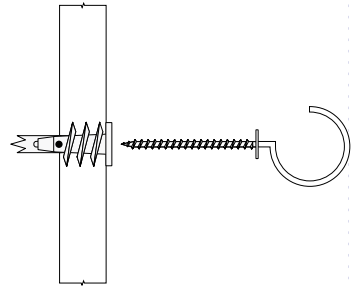

Allowable Fixture Weight 15–20kg

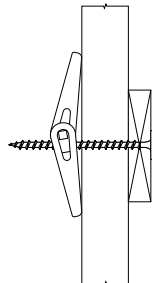

Blisters in Tape	
<p>Description</p> <ul style="list-style-type: none"> – Bubbles appear in areas of the paper jointing tape (ranging in size from approximately 10mm to 40mm, or more) 	<p>Remedy</p> <ul style="list-style-type: none"> – Slit tape to open up blistered area – Fill out with compound, then press tape back in place with broad-knife – When dry, smooth to level finish
<p>Cause</p> <ul style="list-style-type: none"> – Insufficient compound used under tape – Tape not initially pressed into good contact with compound – Too much compound forced from under tape by excessive tool pressure when embedding – Not enough compound in recess – Compound gauge is too dry 	<p>Prevention</p> <ul style="list-style-type: none"> – Provide sufficient compound under entire tape – 0.8mm
Centre Cracking	
<p>Description</p> <ul style="list-style-type: none"> – Cracks appear in the joint down the centre of the joint tape 	<p>Remedy</p> <p>Relieve stress, i.e. providing adequate isolation by installing a control joint and re-taping, then feathering compound over broad area to disguise build-up</p>
<p>Cause</p> <ul style="list-style-type: none"> – Abnormal stress build-up resulting from structural deflection or racking – Excessive stresses resulting from hygrometric and/or thermal expansion and contraction 	<p>Prevention</p> <ul style="list-style-type: none"> – Correct unsatisfactory environmental conditions – Provide sufficient relief and re-tape – Provide proper isolation from structure to prevent stress build-up – Provide adequate control joints – Structurally brace underlying framing – Ensure moisture content of timber is 18% or less

Joint Darkening

Description

- A dark area occurs in the area of the joint commonly as a result of set compound being darker than dried compound

Remedy

- Redecorate after joints are thoroughly dry

Cause

- Occurs most commonly with colour-tinted paint rather than white. Most severe when applied in humid weather or when joints have not fully dried

Prevention

- Be sure joints are thoroughly dry before painting

Edge Cracking

Description

- Cracks at edge of GIB® tape or GIB® Goldline® trims

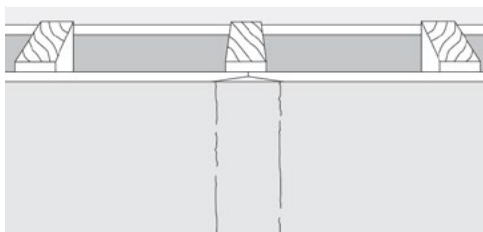

Remedy

- Remove all poorly bonded tape, then reapply compound and tape in correct manner

Cause

- Fast drying of taping compound due to high temperature and low humidity, or excessive drafts
- Improper application, e.g. over-dilution of compound, use of wrong compound, or no second coat over tape
- Cold, wet application conditions (also causes poor bond)

Prevention

- In hot, dry conditions, use GIB Tradeset® 45
- In extreme conditions use a multi-purpose air drying compound. Note: these dry rather than set, so provide more open time
- Place shielding devices over room openings to prevent drafts. Do not apply joint treatment over hot surfaces
- During cold weather, control heat at minimum 10°C and supply good ventilation
- Avoid practices listed under “Cause” opposite

Excessive and/or Delayed Shrinkage

Description

- Shrinkage that occurs after longer time periods or is unusually high

Remedy

- See ‘starved joints’ (p.108)

Cause

- Atmospheric conditions – slow drying and high humidity
- Insufficient drying time between coats of compound
- Excessive water added in mixing compound
- Excessive compound depth
- Combinations of the above

Prevention

- Ensure that each coat of compound is properly dry before applying the next. Ensure a minimum temperature of 10°C is maintained during application and drying of compounds

Shadowing	
<p>Description</p> <ul style="list-style-type: none"> Shows as a build-up of dust, typically once the wall has been decorated 	<p>Remedy</p> <ul style="list-style-type: none"> Wash painted surfaces with warm water and redecorate surface if necessary
<p>Cause</p> <ul style="list-style-type: none"> Temperature differentials in outside walls or top floor ceilings cause airborne dust to collect on colder condensation spots of interior surface 	
Starved Joints	
<p>Description</p> <ul style="list-style-type: none"> Joint area is under filled in relation to the surrounding plasterboard 	<p>Remedy</p> <ul style="list-style-type: none"> Reapply a full coat of compound over tape. Since this is the thickest application most shrinkage occurs in this coat, making it easier to fill taper properly. Finish by standard procedure
<p>Cause</p> <ul style="list-style-type: none"> Delayed shrinkage caused chiefly by insufficient drying time between coats of compound Insufficient compound applied for second taping coat to fill joint recess/taper. Shrinkage usually progresses until drying is complete Over-thinning compound, particularly with boxes 	<p>Prevention</p> <ul style="list-style-type: none"> Allow each coat of compound to dry thoroughly before applying succeeding coat, or use a low-shrinkage setting compound such as GIB Tradeset®, GIB LiteSet® or GIB Lite Blue®
Finish Gloss Variation	
<p>Description</p> <ul style="list-style-type: none"> Variations in gloss level of paint between the plasterboard and joint area 	<p>Remedy</p> <ul style="list-style-type: none"> Allow to 'age' for 3–4 weeks then redecorate. Ensure that the paint is roller applied
<p>Cause</p> <ul style="list-style-type: none"> Differences in suction of the board paper and joint compound. Problem accentuated by strong side lighting with slight angle of incidence to ceiling or wall surface. May also be chemical incompatibility of joint compounds and paint system 	<p>Prevention</p> <ul style="list-style-type: none"> Before painting with high gloss paint, apply skim coat of compound over entire surface (or use a spray on skim coat system) Consider where critical lighting is coming from and move if possible

Paint Sheen Variation

Description

- A differential in gloss levels over the whole area of the wall. This variation can be greater on nail holes and joints, and is highlighted by the use of semi and full gloss paints

Remedy

- Sand back and allow joint compound to fully dry before applying a sealer coat. Then apply correct paint system as per the manufacturer's instructions

Cause

- Nail holes and joints not sealed and undercoated correctly
- Joint compound not fully dry before paint application
- Burnish marks caused by rubbing or washing the wall
- Incorrect sealer used which does not equalise surface absorption of paper and compound

Prevention

- Use correct paint system and apply as per manufacturer's instructions

High Crowns

Description

- Joint area is higher than the surrounding plasterboard and may result in shadowing across the joints

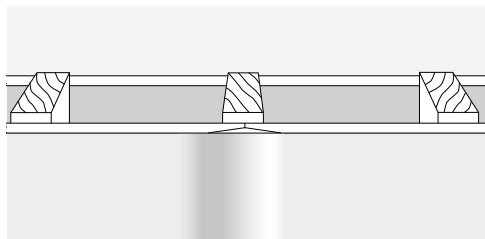

Remedy

- Sand joints to flush surface (take care to avoid scuffing paper or joint tape by over-sanding)

Cause

- Excessive compound over joint
- Compound not feathered out beyond shoulders
- Improper bedding of tape
- Framing out of alignment or sheet edges not tight against framing
- Improper adjustment of mechanical tools
- Misuse of, or worn, tools

Prevention

- Embed tape properly, using only enough compound to cover tape. Adequately feather compound

Tram Lines/Tracks

Description

- Shrinkage of the joint adjacent to the paper tape. Looks like the tape is visible on the joint

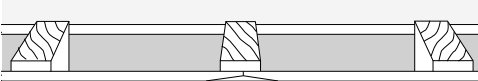

Remedy

- Lightly sand affected areas
- Apply a skim coat to the joint with an air drying compound, and sand and decorate

Cause

- The first coat of compound is not sufficiently dry before the second coat is applied. When the first coat dries it shrinks and pulls the tape back into the joint
- The second and top coat are too thin
- Compound is too thin or watery
- Inadequate drying between coats
- Poor drying conditions
- Slow drying due to excessive filling in one coat
- Premature paint application

Prevention

- Allow joint compound to fully dry between coats

Trim Defects

Description

- Cracks appearing at the edge of GIB® Goldline® Platinum trims

Remedy

- Remove all poorly bonded trims and reapply compound and trims as recommended

Cause

- Taping compound drying too fast, due to high temperatures and low humidity (or excessive drafts) or not enough compound
- Improper application, such as over-dilution of compound, use of wrong compound, excessive compound under tape, or no second coat over tape
- Cold, wet application resulting in poor bond

Prevention

- Do not install at temperatures below 10°C. During cold weather, control heat at a minimum 10°C and supply good ventilation. In hot, dry conditions, place shielding devices over room openings to prevent drafts. Do not apply joint treatment over hot surfaces. Lightly wet down floors if room humidity is too low
- Avoid practices listed under “Causes” opposite

Description

- Protrusions or bumps directly over the nail/screw head
- Rupture of the surface around nail/screw head
- Looks like nail/screw head protruding above the surface of the board

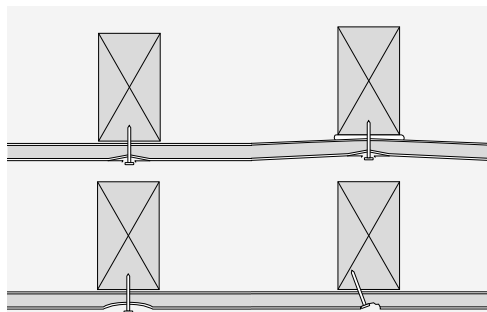

Cause

- Timber shrinkage (timber shrinks as it dries, causing the fastener to protrude). Nail/screw pops may not become apparent for some considerable time after installation
- Fixing through glue – if screws or nails are applied through adhesive, a pop can occur as the glue dries and shrinks back; pulling the plasterboard closer to the framing member
- Plasterboard not held in close contact with the framing members. If the plasterboard is not held firmly against the stud while fixing, it increases the possibility of over-driving the nail (resulting in a blister-like defect the size of the hammerhead)
- Overdriven or skewed nails/screws can puncture the face paper, which results in no holding power
- Air trapped between the fixture and the compound, when the compound is placed
- Nail heads/screw heads puncturing face paper

Remedy

- Nail pops that occur after at least one month's heating cycle are probably caused by timber shrinkage. Because further shrinkage is likely to occur and pops reappear, do not repair until the end of a heating season
- A screw should be reapplied 50mm from the popped fastener. Drive in a new fastener whilst applying firm pressure, to ensure firm contact with framing. Use a nail punch to seat the popped fastener beneath the surface of the plasterboard
- Remove compound. Apply two coats of setting compound followed by an air dry compound coat, then redecorate

Prevention

- Avoid timber shrinkage by using GIB® Rondo® metal ceiling battens for ceilings or kiln dried timber. Close in the building and protect the framing from the elements as soon as possible. Ensure that timber moisture content is 18% or less at the time of lining. Use of steel battens for large ceiling areas will eliminate shrinkage factors
- Fixing through glue – for walls, use nails/screws around the perimeter and GIBFix One® or GIBFix® All-Bond adhesive in the centre of the sheet. No mechanical fastener should be within 200mm of an adhesive daub. Never nail/screw through glue
- Plasterboard not in close contact with the framing members – when fixing ceilings, fix the centre of the plasterboard first. In all cases hold the plasterboard firm against the framing member whilst fixing
- Drive nails/screw in straight so they are neatly seated slightly below the surface of the sheet
- Apply compound in critical light areas by pressing the compound into the fixings, rather than trowelling it on. This removes trapped air

Peaking

Description

- A condition where joints are visible under critical lighting
- More prevalent when board has been installed in cold weather
- Often called ridging or beading
- Looks like a continuous ridge along the length of the joint, with a uniform peak-like pattern at the centre
- Commonly occurs in conjunction with ‘nail popping’

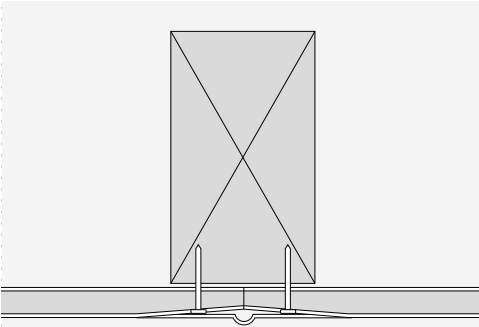

Remedy

- Ridges must only be repaired after a full heating cycle (6 months to a year). Mid-summer is generally the best time for rectifications
- Apply a coat of setting compound over the joints using a 300mm trowel to widen the joint. Scrape back and apply a light coat of a topping coat. Reseal affected area. Examine the surface with harsh lighting to determine whether the ridge has been concealed. If all right, then decorate

Cause

- Excessive gaps (i.e. over 2mm) left between sheets
- Timber movement due to excessive moisture content of timber at time of lining and subsequently drying out. This is more prevalent with 10mm plasterboard than thicker plasterboards
- No gaps at the base of wall sheets. This can cause pressure on the base of the sheets thus transferring tension to the joints
- Inadequate ventilation with concrete floor slabs, resulting in a build-up of water vapour

Prevention

- Use GIB® Rondo® metal ceiling battens on ceilings
- Ensure timber framing moisture content is 18% or less at time of lining
- Use a back blocking system on ceilings
- Gaps between sheets should be pre-filled with a setting compound and allowed to completely dry before application of tape and subsequent coats of compound
- Always allow a 5mm-10mm gap at the base of wall sheets to allow for shrinkage of the wall plates and studs
- Ensure compound materials are maintained at a minimum temperature of 10°C during, and following, installation. Allow adequate ventilation

Peeling/Flaking, Severe Cracking

Description

- Large flakes that adhere loosely to the surface
- This problem is an extension of cracking and the causes and remedies are the same

Shrinkage

Description

- Compound shrinking back when it dries, causing a depression at the joint or on a fastener
- Looks like depressions at the joint

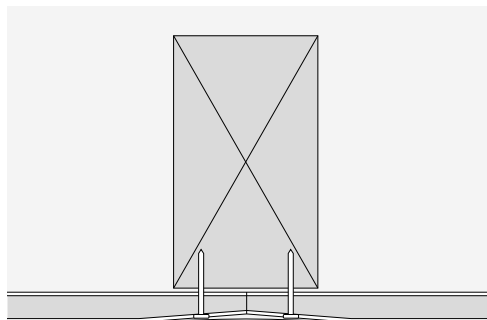

Remedy

- Lightly sand affected areas and apply air drying compound, then sand (using 220 grit or finer sand paper)
- Seal repaired areas and then re-decorate

Cause

- Compound too thin or watery
- Inadequate drying between coats
- Slow drying due to excessive filling in one coat
- Under slow drying conditions, joints and plasterboard may hold moisture for weeks

Prevention

- Provide proper drying conditions for compound. The two setting coats must be thoroughly dry prior to top coating. The top coat must be thoroughly dry prior to application of sealer
- Use compound at heaviest workable consistency and allow to stand for 2–3 minutes before applying
- In slow drying conditions apply a number of thinner coats rather than a few thick coats
- Under slow drying conditions use shorter set time joint compounds
- Allow joint compound to fully dry between coats

Paint Checking/Cracking

Description

- Small splits or star shape cracks on paint film surface

Remedy

- Remove paint allow joint compound to fully dry, repair any damage and reapply paint (as per manufacturer's instructions)

Cause

- Joint or topping compound not fully dry before paint application
- Paint not fully dried before next application
- Paint applied too thick
- Incorrect paint used

Wavy surfaces

Description

- Plasterboards are not flat but have a bowed, dished or undulating surface
- Studs or ceiling joists not on the same plane as other framing members
- A twisted framing member
- Shadows being cast across the joint
- Plasterboard forced into place

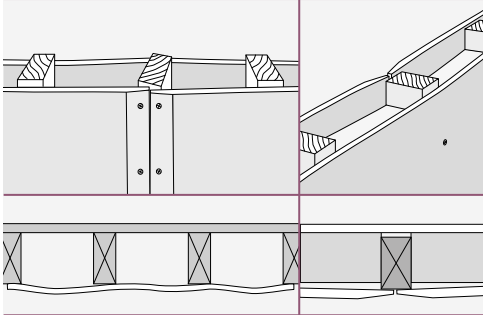

Cause

- Framing oversights
- Framing out of alignment with adjacent framing, making it difficult to bring the sheet into firm contact with framing members
- Excessive moisture in the timber framing can also cause warping, twisting or bowing as it dries
- Fixing the perimeter of the sheet prior to the centre
- Fixing of damp plasterboard
- Excessive loading from insulation or light fittings causing too much weight on plasterboard
- Incorrect placement of vapour barrier causing moisture build-up within the plasterboard
- Exceeding maximum span of fasteners when fixing
- Not allowing a 5mm–10mm gap between the floor and the plasterboard
- Incorrect fastening sequence for lining light gauge steel framing
- High temperatures in the ceiling space causing board expansion, particularly in skillion roofs with poor ventilation
- Incorrect storage – storing of plasterboard on edge on damp concrete floors

Remedy

- It is extremely difficult to rectify some of these problems without having to resort to full replacement of the linings after rectifying underlying factors
- Replace all warped or crooked studs

Prevention

- Timber members must be brought into alignment
- Check stud, batten and joist alignment, correcting wherever necessary
- Always fix from the centre outwards
- Sheets must be touch fitted and not forced into place

Fibre Raise Adjacent to Joint Areas

Description

- A shadow adjacent to the stopped area

Prevention

- Lightly sand between all coats

Cause

- Commonly encountered with spray applied sealer and top coats which have not been lightly sanded back between coats
- Also common where alkyd sealers are used and not sanded back before the application of top coats
- Excessive sanding of paper raising fibres

Compound Defects

Grit

- Small pieces of raw material or contaminant that show up when the compound is trowelled

Shrinkage

- The compound shrinks back into the joint when it dries. Caused by thick coats of compound, not allowing the compound to dry between coats and using incorrect mixing ratios

Seeding/Lumps

- Small lumps of hard compound that can form towards the end of a compounds working time. Can be due to contamination, over mixing, dirty tools, or particles of dry compound left in the mixing bowl

Inconsistent Set Time

- Setting compounds having a different set time to those stated on the bag. There are a number of probable causes including contamination, particles of dry compound left in the mixing bowl, variable water temperature, over mixing and re-working, as well as inappropriate product storage

Board Defects

Delamination

- Separation of the paper ply from the main body of the paper. Paper still adhered to the core with weak inter-ply bond.

Peeler

- Paper liner coming away cleanly from the core with no paper adhesion. Caused by calcinated (over dried) board. Also occurs when the plasterboard is damp

End Split

- Peeling or splitting 50mm–100mm from end of sheet
- Usually caused by soft board at the knives during the manufacture of plasterboard

Shoulder

- The thickness of the board at the inner edge of the taper is greater than that in the body of the board itself

Cupped or Hooked Edges

- Scalloped or hooked. Taper does not have regular profile
- Can be caused during manufacture or incorrect storage of the board edge on damp concrete surfaces

Soft Edges

- Soft core or calcinated due to over drying of the edge
- Damp due to storage on damp concrete surfaces

Blisters

- Intermittent splitting of the core and paper

Notes

Lined area for writing notes, consisting of 20 horizontal lines.



FOR MORE INFORMATION VISIT

gib.co.nz

OR CALL THE GIB® HELPLINE

0800 100 442